

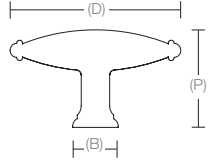

Tuscany Bronze Cabinet Knob & Pull Specifications

Tuscany Bronze Fluted Finger Knob

		Product Code	Dimension(D)	Projection(P)	Base Diameter(B)	Width(W)
		86227	1 3/4"	1 1/4"	1 1/16"	9/16"
		86228	3"	1 5/8"	1 3/16"	1 1/16"

Tuscany Bronze Twist Knob

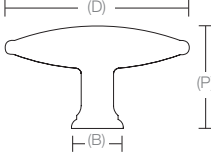
		Product Code	Dimension(D)	Projection(P)	Base Diameter(B)	Width(W)
		86097	1 3/4"	1 1/4"	1 1/16"	9/16"
		86098	3"	1 3/4"	1 3/16"	1 1/16"

Tuscany Bronze Fluted Knob

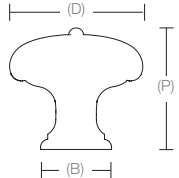
		Product Code	Dimension(D)	Projection(P)	Base Diameter(B)
		86229	1"	1 1/8"	5/8"
		86230	1 1/4"	1 1/4"	1 1/16"
		86231	1 3/4"	1 1/2"	1 3/16"

Tuscany Bronze Twist Round Knob

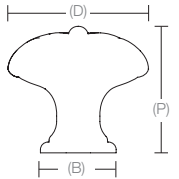
		Product Code	Dimension(D)	Projection(P)	Base Diameter(B)
		86244	1"	1 1/8"	5/8"
		86245	1 1/4"	1 1/4"	1 1/16"
		86246	1 3/4"	1 1/2"	1 3/16"

Tuscany Bronze Egg Knob

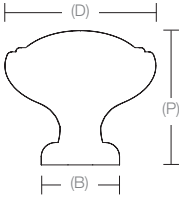
		Product Code	Dimension(D)	Projection(P)	Base Diameter(B)
		86093	1"	1"	5/8"
		86094	1 1/4"	1 1/4"	1 1/16"
		86143	1 3/4"	1 1/2"	1 3/16"

Tuscany Bronze Petal Knob

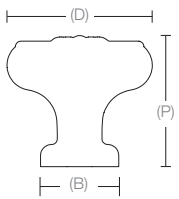
		Product Code	Dimension(D)	Projection(P)	Base Diameter(B)
		86095	1"	1"	5/8"
		86096	1 1/4"	1 1/4"	3/4"
		86214	1 3/4"	1 1/2"	7/8"

Tuscany Bronze Cabinet Knob & Pull Specifications

Tuscany Bronze Round Knob

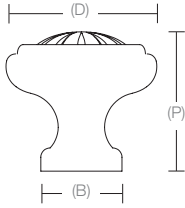
		Product Code	Dimension(D)	Projection(P)	Base Diameter(B)
		86091	1"	1"	5/8"
		86092	1 1/4"	1 1/4"	3/4"
		86116	1 3/4"	1 1/2"	13/16"

Tuscany Bronze Octagon Knob

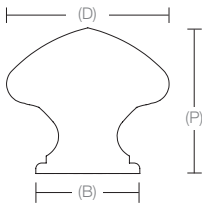
		Product Code	Dimension(D)	Projection(P)	Base Diameter(B)
		86137	1"	1"	3/4"
		86138	1 1/4"	1 1/4"	3/4"
		86215	1 3/4"	1 5/8"	1"

Tuscany Bronze Ribbed Pull

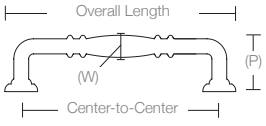
		Product Code	Overall Length	Dimension C-to-C	Projection(P)	Width(W) Center Only
		86100	3 5/8"	3"	1"	7/16"
		86101	4 1/8"	3 1/2"	1"	7/16"
		86102	4 5/8"	4"	1"	7/16"
		86255	6 5/8"	6"	1"	1/2"

Tuscany Bronze Fluted Fixed Pull

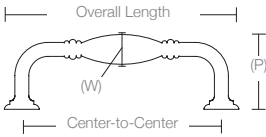
		Product Code	Overall Length	Dimension C-to-C	Projection(P)	Width(W) Center Only		
		86218	3 3/4"	3"	1 1/2"	5/8"		
		86219	4 1/4"	3 1/2"	1 1/2"	5/8"		
		86220	4 3/4"	4"	1 1/2"	5/8"		
		86221	6 3/4"	6"	1 1/2"	1 1/16"		
		86222	8 3/4"	8"	1 1/2"	1 1/16"		
		86223	10 3/4"	10"	1 1/2"	1 1/16"		
		<i>Also available in Appliance Pulls:</i>						
		86347	12 15/16"	12"	2"	7/8"		
		86348	18 15/16"	18"	2"	7/8"		

Tuscany Bronze Twist Fixed Pull

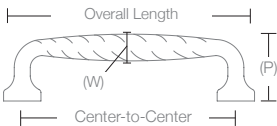
		Product Code	Overall Length	Dimension C-to-C	Projection(P)	Width(W)
		86103	3 5/8"	3"	1 1/4"	1/2"
		86104	4 1/4"	3 1/2"	1 1/4"	1/2"
		86105	4 1/2"	4"	1 1/4"	1/2"
		86238	6 3/4"	6"	1 3/8"	9/16"
		86239	8 3/4"	8"	1 3/8"	5/8"
		86240	10 3/4"	10"	1 3/8"	5/8"

Tuscany Bronze Bin Pull

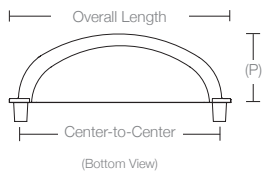
		Product Code Overall Length Dimension C-to-C Height Projection(P) Width(W)
		86099 3 1/2" 3" 1 5/8" 1" 1 3/8"
		86199 4 1/2" 4" 2" 1" 1 5/8"

Tuscany Bronze Fluted Bin Pull

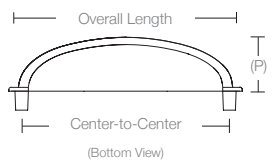
		Product Code Overall Length Dimension C-to-C Height Projection(P) Width(W)
		86232 3 5/8" 3" 1 3/4" 1" 1 1/2"
		86233 4 1/2" 4" 1 7/8" 1" 1 5/8"

Tuscany Bronze Back Plate for Knob

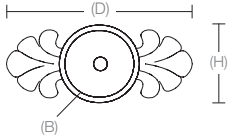
		Product Code Dimension(D) Height(H) Diameter(B)
		86234 2 1/4" 7/8" 1"

Tuscany Bronze Back Plate for Pull

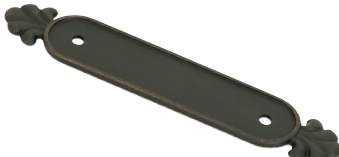
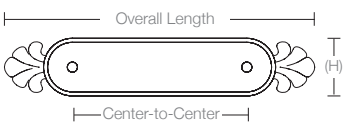
		Product Code Overall Length Dimension C-to-C Height(H)
		86235 5 3/8" 3" 7/8"
		86236 5 7/8" 3 1/2" 7/8"
		86237 6 3/8" 4" 7/8"