



FVN62-3012-UNS TORINO

INSTALLATION GUIDE

CONTENTS:

Cabinet	(FCB62-3012)	PAGE 3
Sink	(FVS6230)	PAGE 4
Mirror	(FMR6230)	PAGE 2

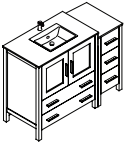

FVN62-3012-UNS
TORINO
INSTALLATION GUIDE



Mirror

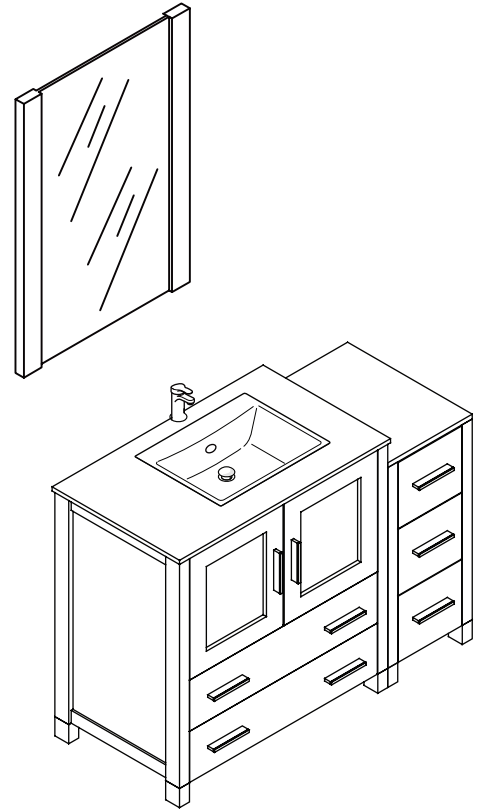
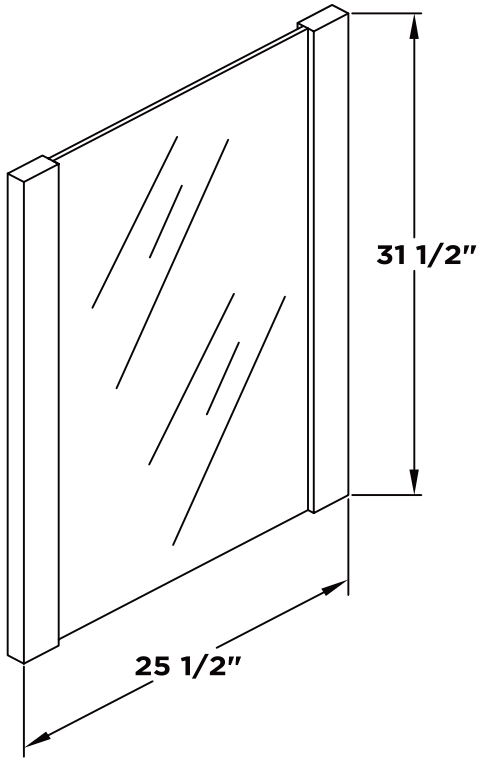

Vanity Front

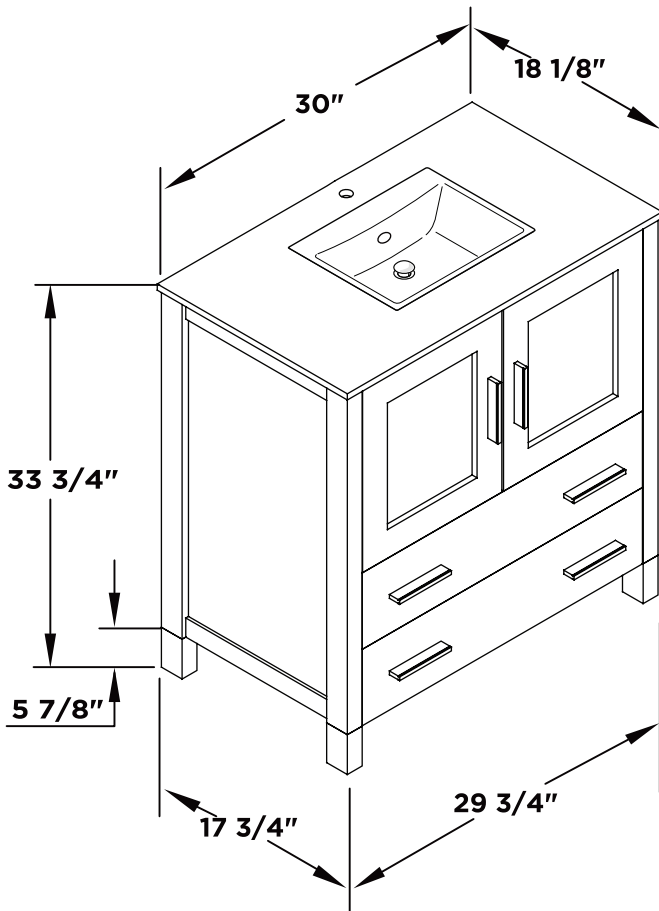

Vanity Back

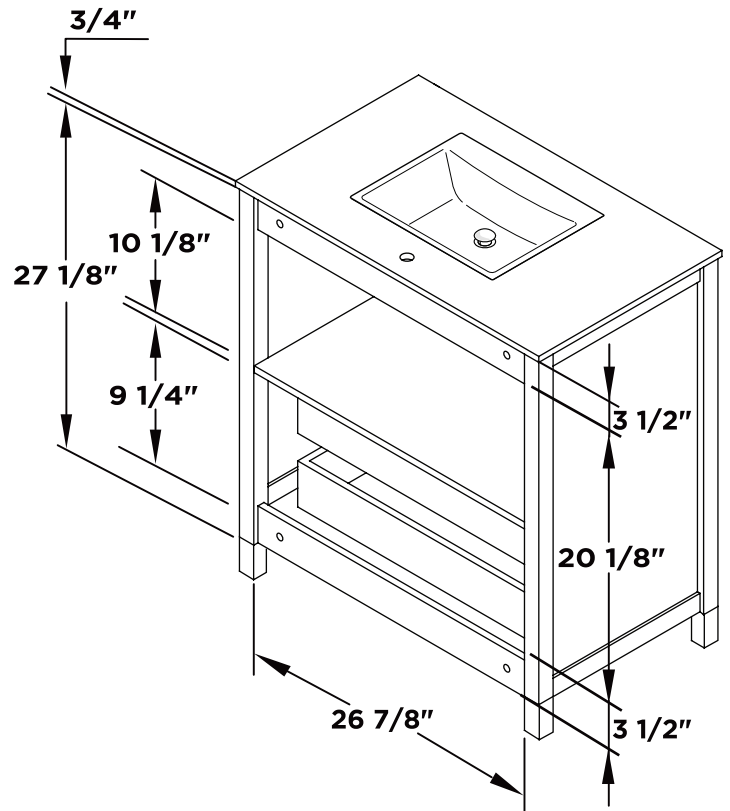

TOOLS FOR ASSEMBLY

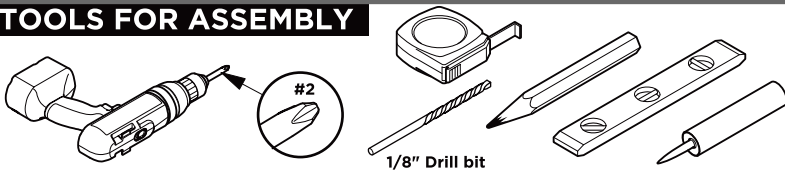

Side Cabinet Front

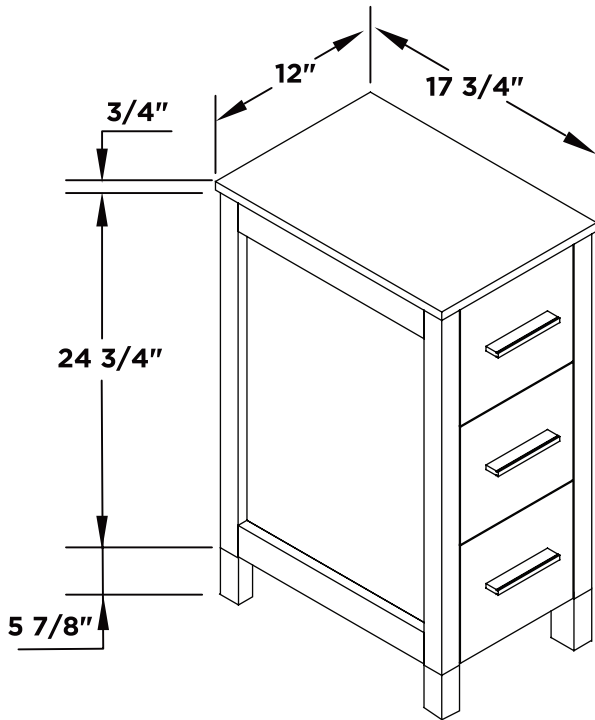

Side Cabinet Back

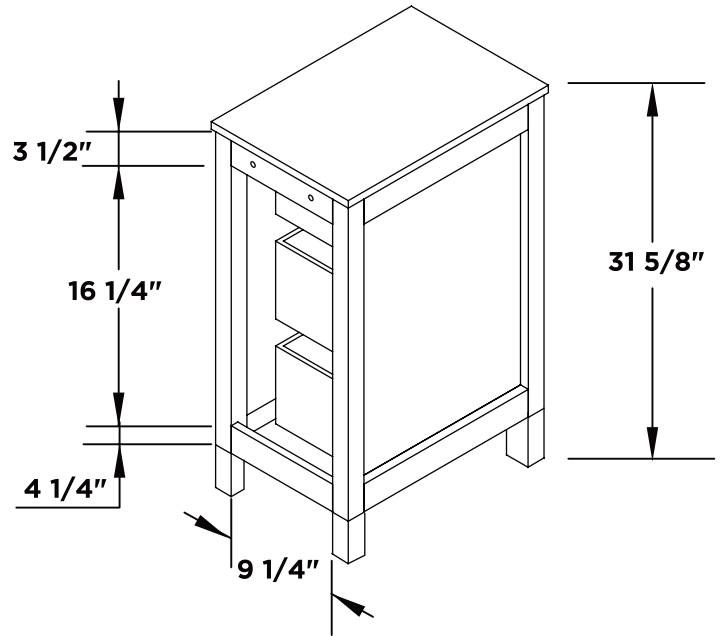

MIRROR INSTALLATION

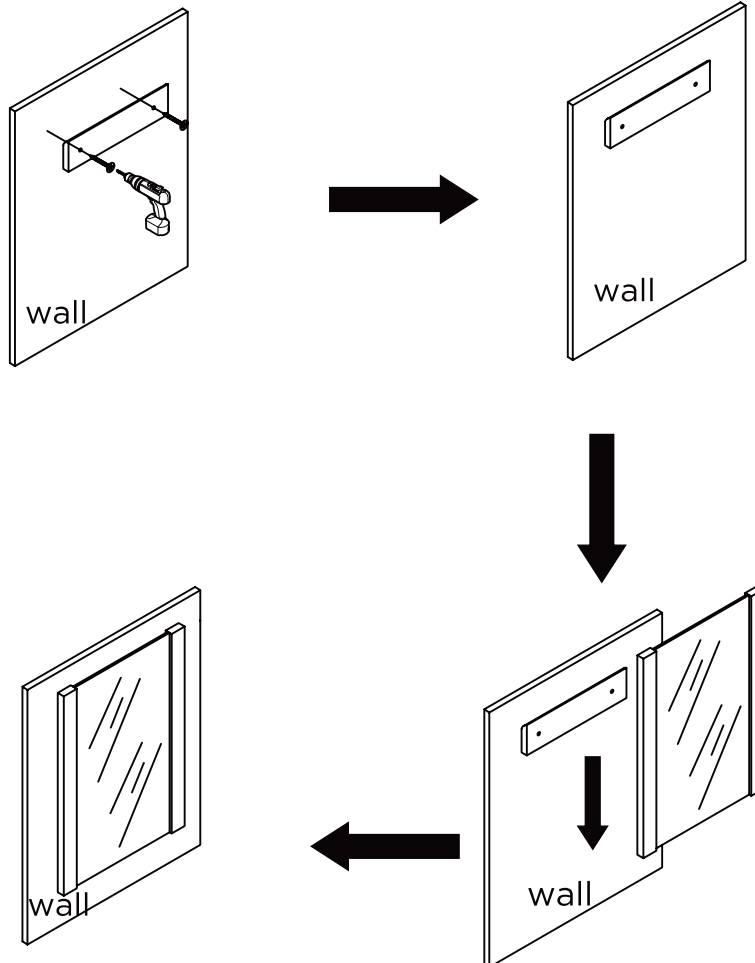

DRAWER REMOVAL & INSTALLATION

REMOVAL

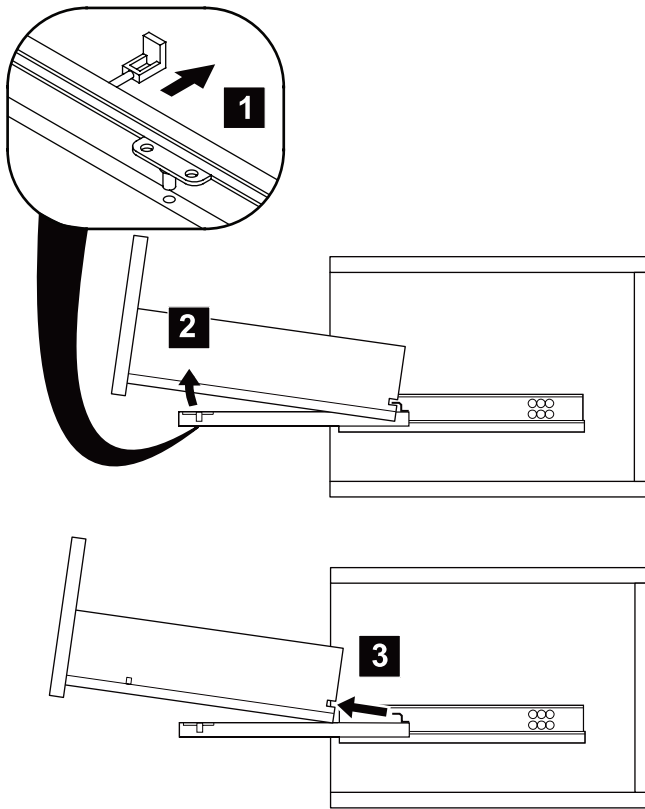

INSTALLATION

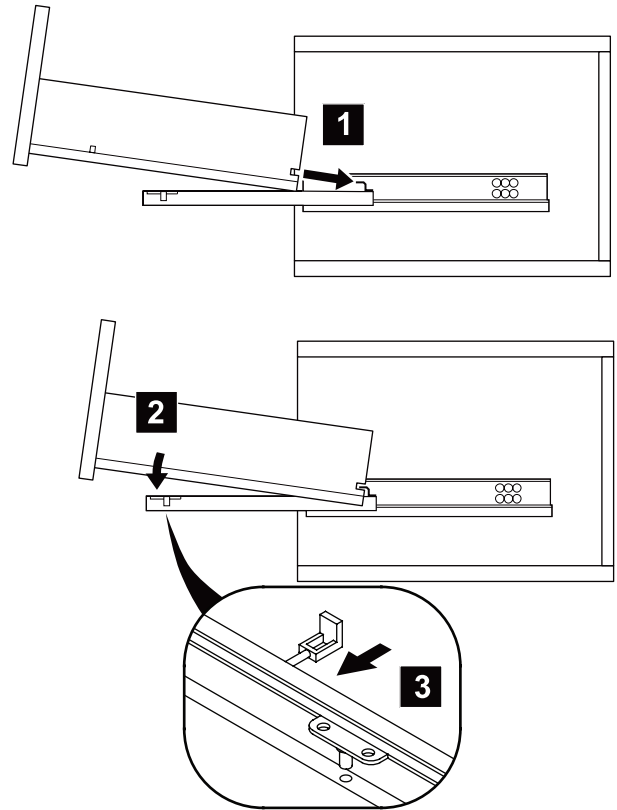

1 Install leg

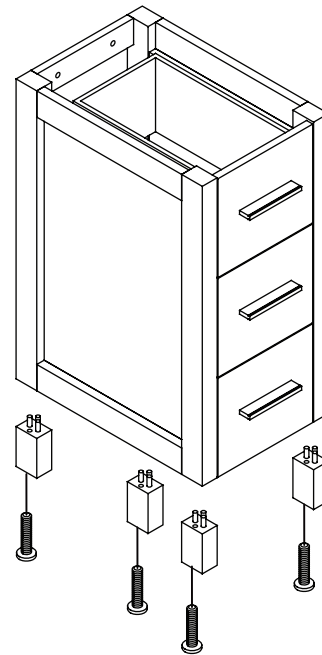
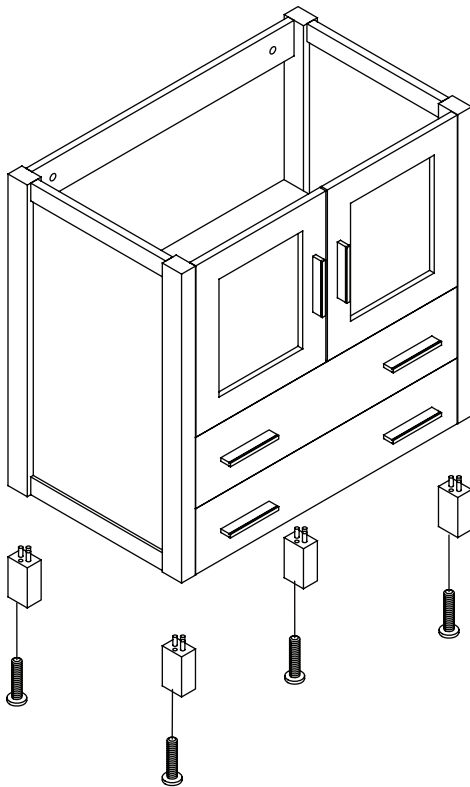

2 Remove drawer

3 Install cabinet

IMPORTANT: Consult an expert for the proper screws/bolts to use when attaching to various wall constructions. Screws provided do not attach to all wall construction types.

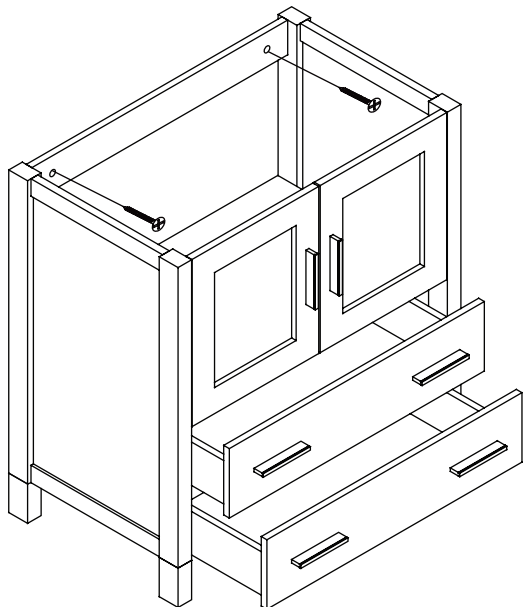

4 Install top panel

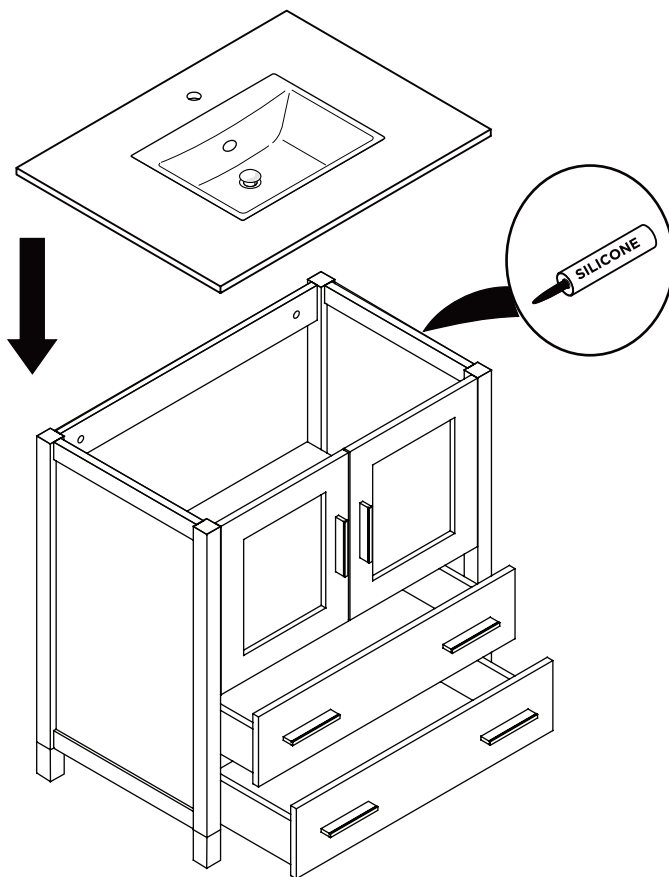

5 Remove side cabinet drawer

6 Install side cabinet

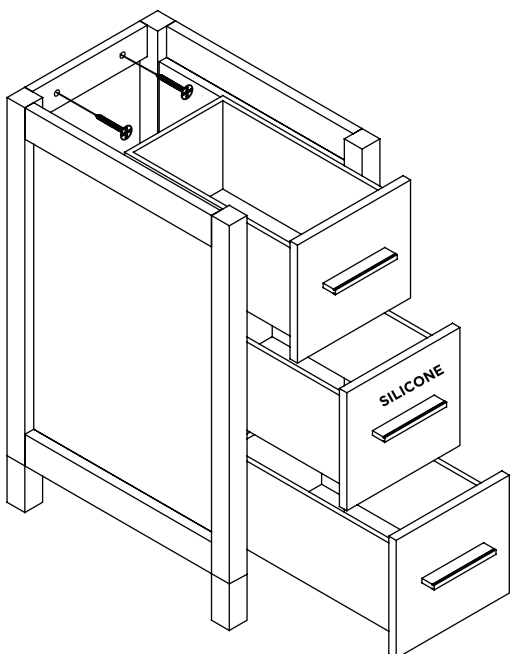

7 Install side cabinet top panel

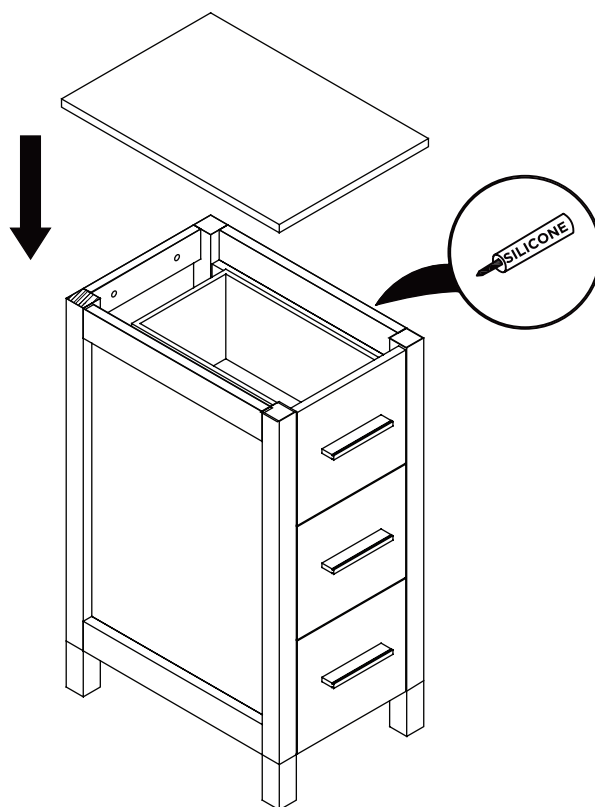

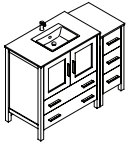

FVN62-3012-UNS TORINO INSTALLATION GUIDE

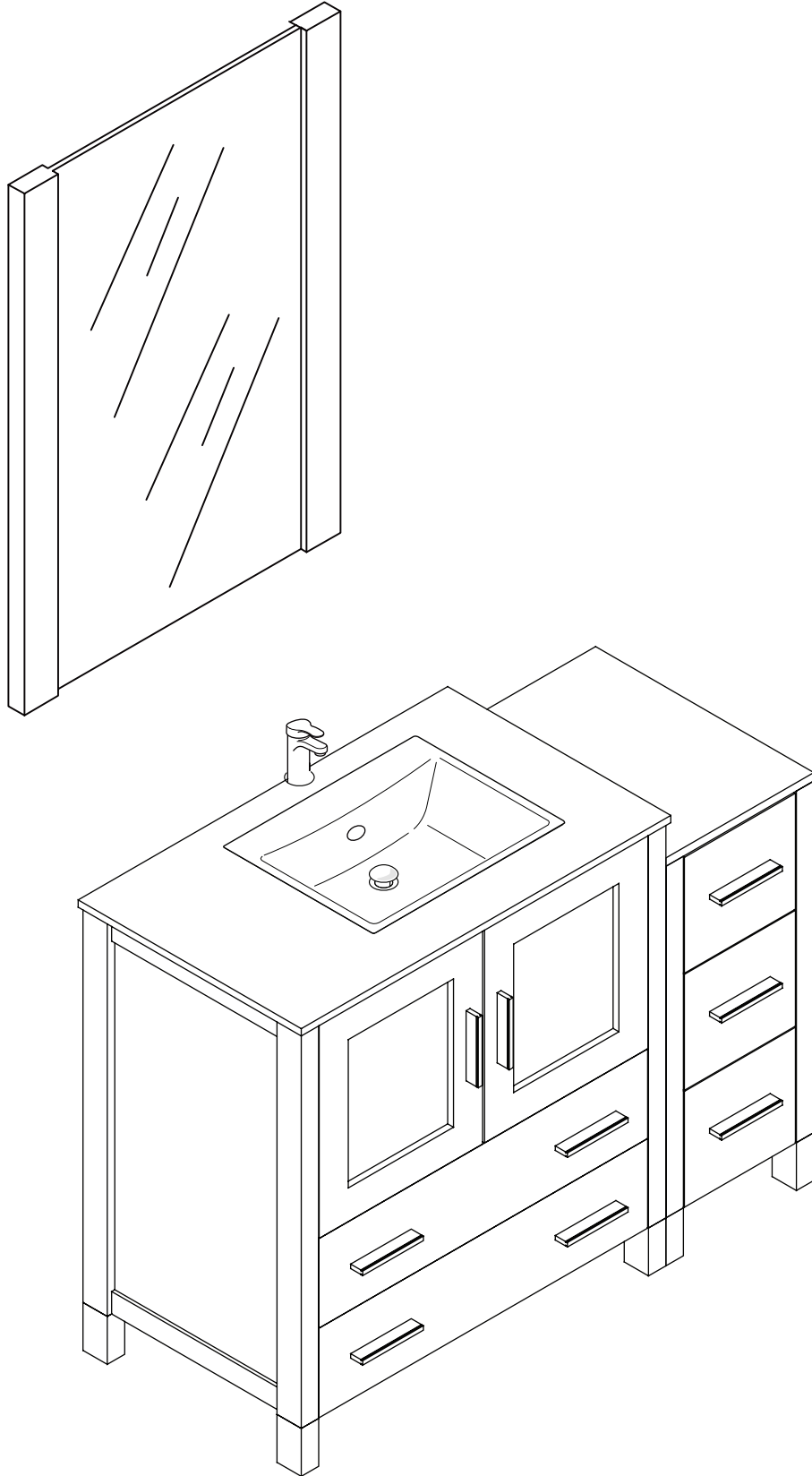

P-TRAP & POP-UP

INSTALLATION INSTRUCTIONS

Your item may appear slightly different from the illustration.

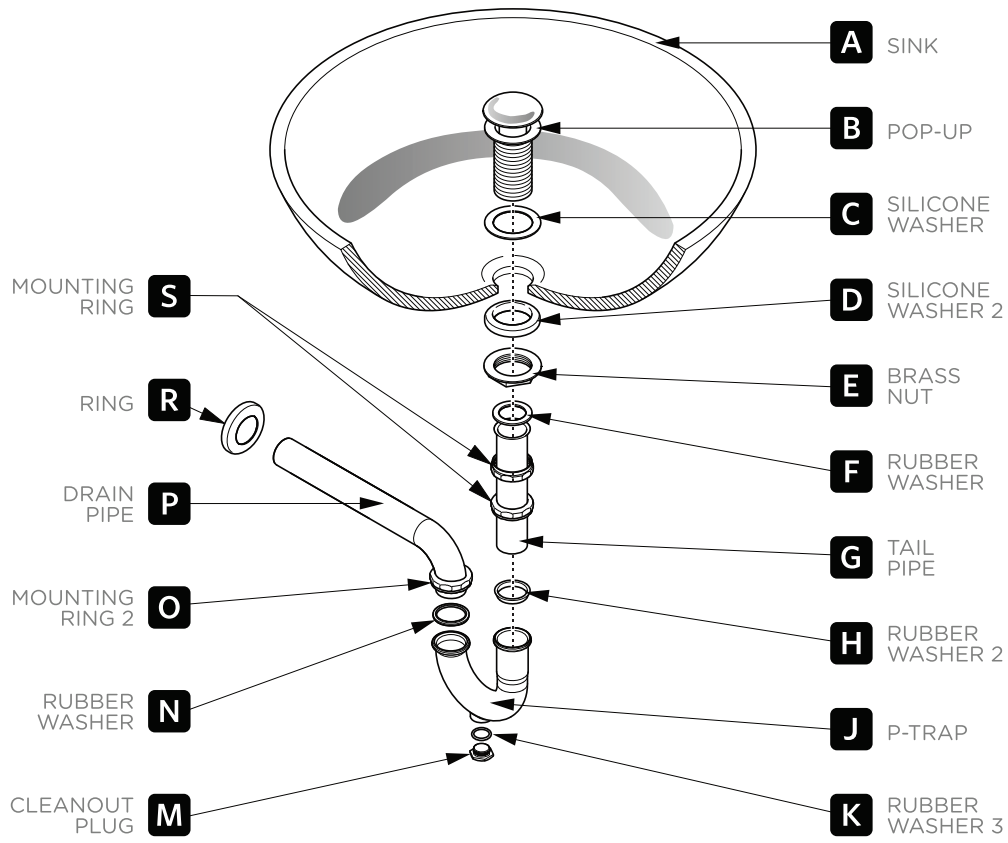

POP-UP INSTALLATION

FOR SINKS WITHOUT OVERFLOW

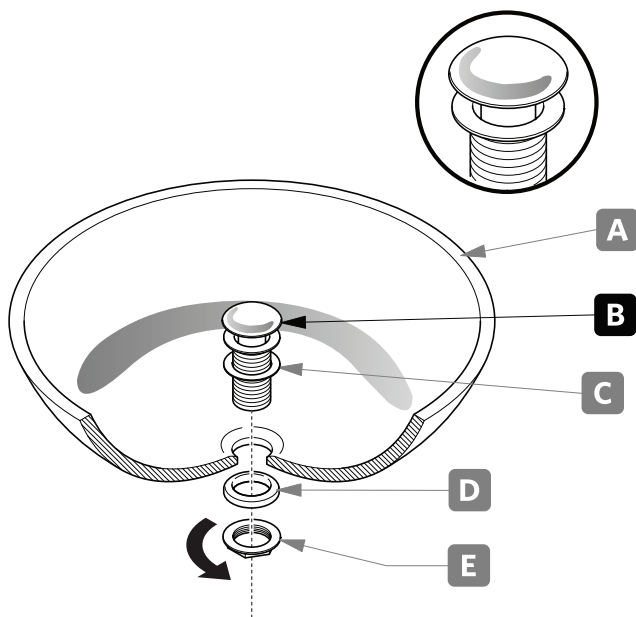

OR

FOR SINKS WITH OVERFLOW

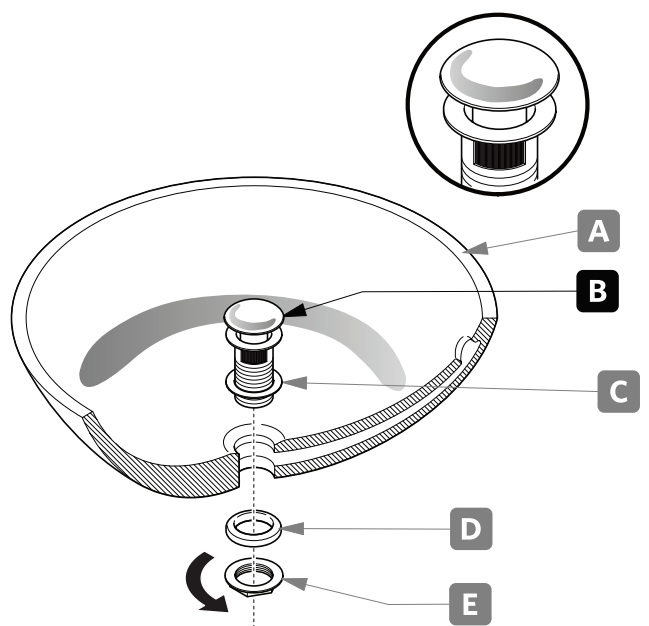

P-TRAP INSTALLATION

1. Install tail pipe (**G**).

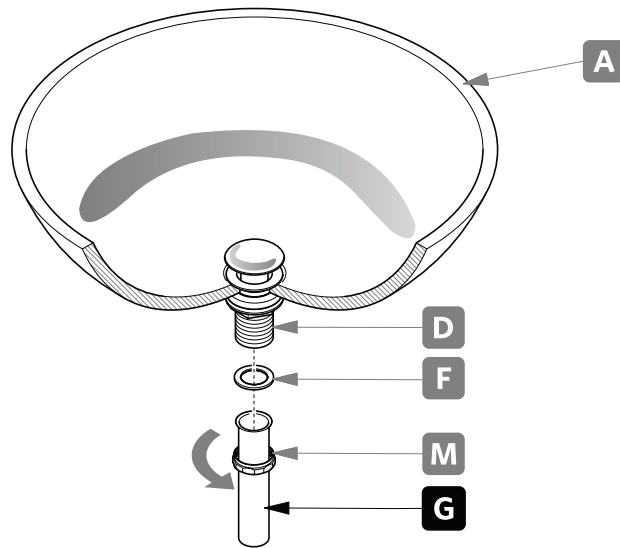

2. Install P-trap (**J**).

