

Models/Modelos/Modèles  
**9190-DST & 9190T-DST**  
 Series/Series/Seria  
**BRODERICK™**

**RP100845▲**

Escutcheon, Mounting Screws (2), Gasket, Nuts (2) & Washers (2) (not included)  
 Chapa, tornillos de montaje (2), empaque, tuercas (2) y arandelas (2) (no se incluyen)  
 Plaque de finition, vis de montage (2), joint, écrous (2) et rondelles (2) (non inclus)

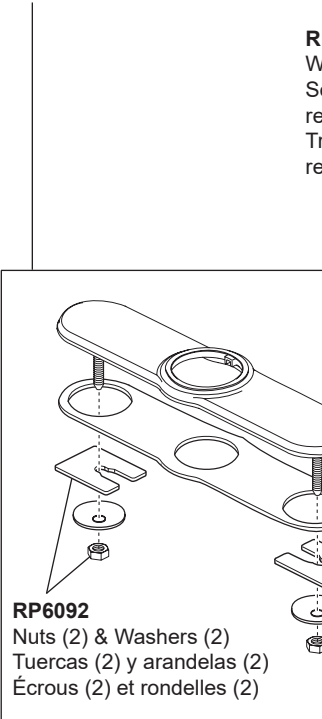

**RP6092**

Nuts (2) & Washers (2)  
 Tuercas (2) y arandelas (2)  
 Écrous (2) et rondelles (2)

**RP80977**

Wand Retainer & Replacement Kit  
 Soporte para el mango y piezas de repuesto  
 Trousse de rechange et pièce de retenue de douchette



**RP100833▲**  
 Sprayer Assembly  
 Ensemble de rociador  
 Pulvérisateur

**RP100832**  
 Gasket  
 Empaque  
 Joint

**RP80523**

Hose Weight Assembly  
 Peso de la manguera  
 Masselotte du tuyau



**RP64075**

Indicator Base Assembly  
 Ensemble de la base con indicador  
 Base à voyant indicateur

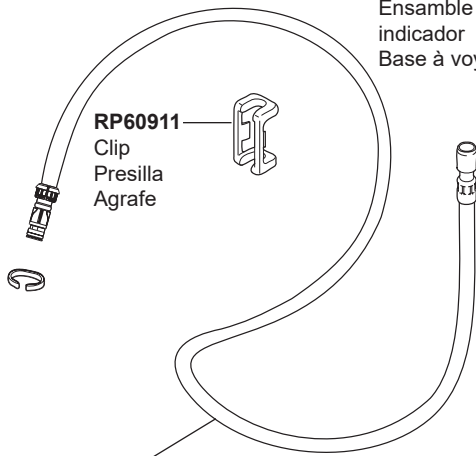

**RP60911**  
 Clip  
 Presilla  
 Agrafe

**RP80522**

Hose Assembly  
 Ensemble de la manguera  
 Tuyau souple

**RP100829▲**

Spout  
 Canalón  
 Bec

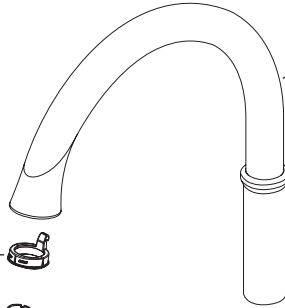

**RP60923**

Retainer  
 Funda  
 Douille



**RP91902**

Cartridge Assembly  
 Ensemble de la válvula  
 Soupape

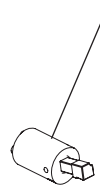

**RP90781**

O-Ring  
 Anillo O  
 Joint toriques



**RP100836▲**

Cap  
 Bonete  
 Chapeau

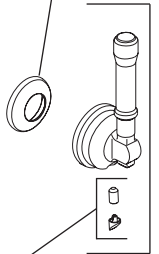

**RP78741**

Contact Spring  
 (for 9190T)  
 Resorte de contacto (para 9190T)  
 Ressort de contact (pour 9190T)

**RP74776**

Bonnet Nut  
 Tuerca  
 Écrou

**RP100835▲**

Set Screw & Button  
 Tornillo de ajuste y botón  
 Vis de calage et bouton

**RP100834▲**

Handle, Set Screw & Button  
 Manija, tornillo de presión y botón  
 Poignée, vis de calage et bouton

**RP13938**

O-Rings (2)  
 Anillos "O" (2)  
 Joints torique (2)

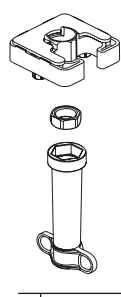

**RP51243**

Inlet Gaskets  
 Empaques para el tubo de entrada  
 Joints côté alimentation

**RP92714**

Mounting Bracket Assembly, Nut & Wrench  
 Ensemble del soporte de montaje, la tuerca y la llave de tuercas  
 Fixation de montage, écrou et clé

▲Specify Finish/Especifíquelo el acabado/Précisez le fini

Models/Modelos/Modèles  
**9190-DST & 9190T-DST**  
 Series/Series/Seria  
**BRODERICK™**

**EP92546**  
 Solenoid Assembly  
 Ensemble de solenoïde  
 Electrovanne

For CZ, PC, SS, AR & KS finishes, order **EP92546**  
 For BL, MW, RB & SP finishes, order **EP92546XX**

Para acabados CZ, PC, SS, AR y KS, ordene **EP92546**  
 Para acabados BL, MW, RB y SP, ordene **EP92546XX**

Pour les finis CZ, PC, SS, AR et KS, commandez **EP92546**  
 Pour les finis BL, MW, RB et SP, commandez **EP92546XX**

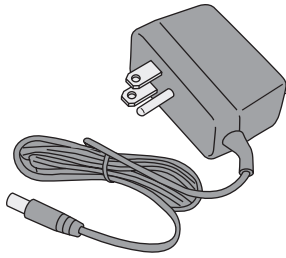

**EP102157**  
 9 Volt Power Supply  
 (Accessory Order Only)  
 Fuente de alimentación de 9 voltios  
 (Orden de accesorios solamente)  
 Alimentation électrique 9 volts  
 (L'accessoire seulement)

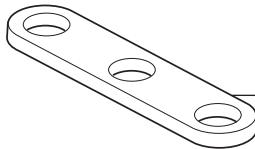

**RP37490**  
 Thin Deck Aid (Not Included)  
 Soporte para encimera delgada  
 (No incluido)  
 Plaque de renfort (non incluse)



**RP83779**  
 Pump  
 Bomba  
 Pompe

**RP100632▲**  
 Dispenser Assembly  
 (Not included)  
 Ensemble del dispensador (no se incluyen)  
 Distributeur (non inclus)

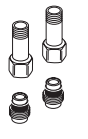
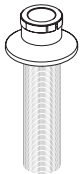

**RP53468**  
 Check Valves  
 Válvulas  
 Checadoras  
 Clapets de non-retour

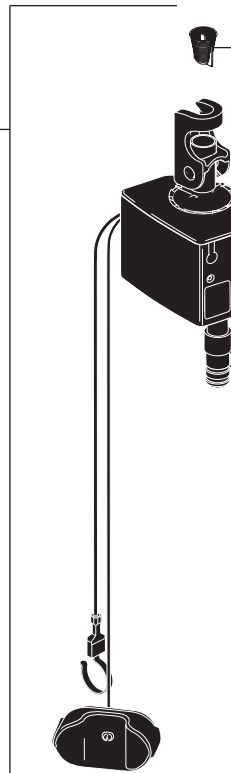

**RP93410**  
 Filter  
 Filtro  
 Filtre

**RP13938**  
 O-Ring (2)  
 Anillo "O" (2)  
 Joint torique (2)



**RP60911**  
 Clip  
 Presilla  
 Agrafe



**RP78389**  
 Battery Box  
 Caja de la batería  
 Boîtier de piles

Other useful accessories that may be purchased separately.  
 Otros accesorios útiles que se pueden comprar por separado.  
 Autres accessoires utiles pouvant être achetés séparément.

**RP63263**  
 Adapters  
 3/8"-24 UNEF to 1/2"-20 UN &  
 3/8"-24 UNEF to 1/2"-14 NPSM  
 Adaptadors  
 3/8"-24 UNEF a 1/2"-20 UN &  
 3/8"-24 UNEF a 1/2"-14 NPSM  
 Adapteurs  
 3/8 po-24 UNEF à 1/2 po-20 UN et  
 3/8 po-24 UNEF à 1/2 po-14 NPSM

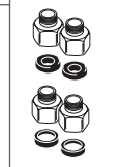

**RP63264**  
 Adapters (10) 3/8"-24 UNEF to 1/2"-20 UN  
 Adaptadors (10) 3/8"-24 UNEF a 1/2"-20 UN  
 Adapteurs (10) 3/8 po-24 UNEF à 1/2 po-20 UN



**RP63265**  
 Adapters (10) 3/8"-24 UNEF to 1/2"-14 NPSM  
 Adaptadors (10) 3/8"-24 UNEF a 1/2"-14 NPSM  
 Adapteurs (10) 3/8 po-24 UNEF à 1/2 po-14 NPSM

