



FRESCA®

FVN6236-UNS

TORINO

INSTALLATION GUIDE

CONTENTS:

Cabinet...(FCB6236).....	PAGE 3 (STEP 3)
Sink.....(FVS6236).....	PAGE 4 (STEP 4)
Mirror.....(FMR6236).....	PAGE 2

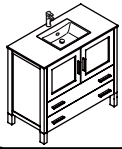

Mirror

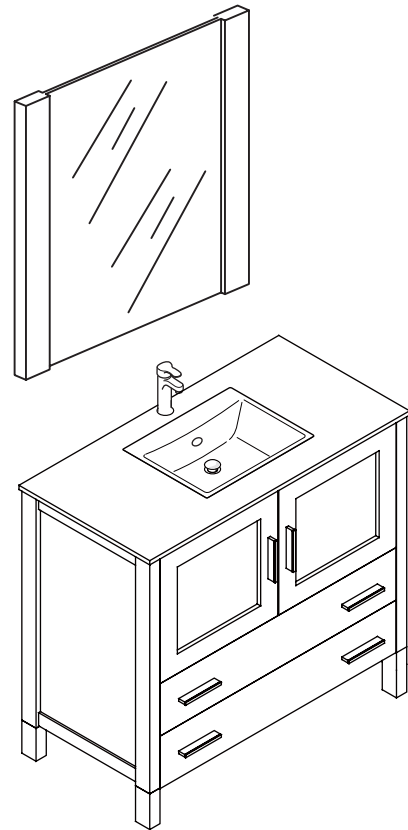
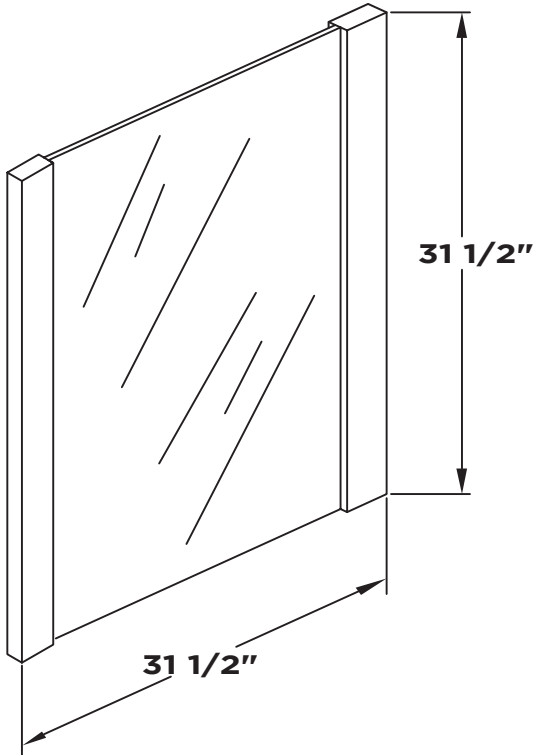

Vanity Front

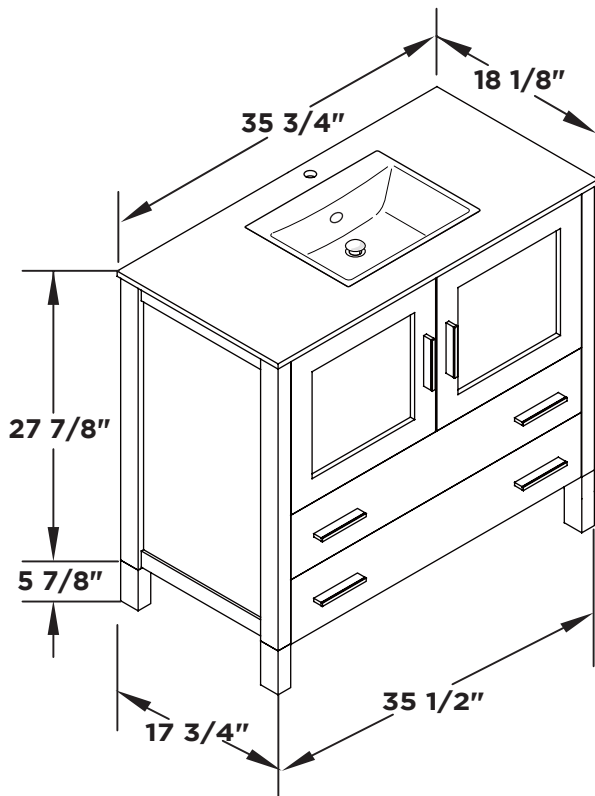

Vanity Back

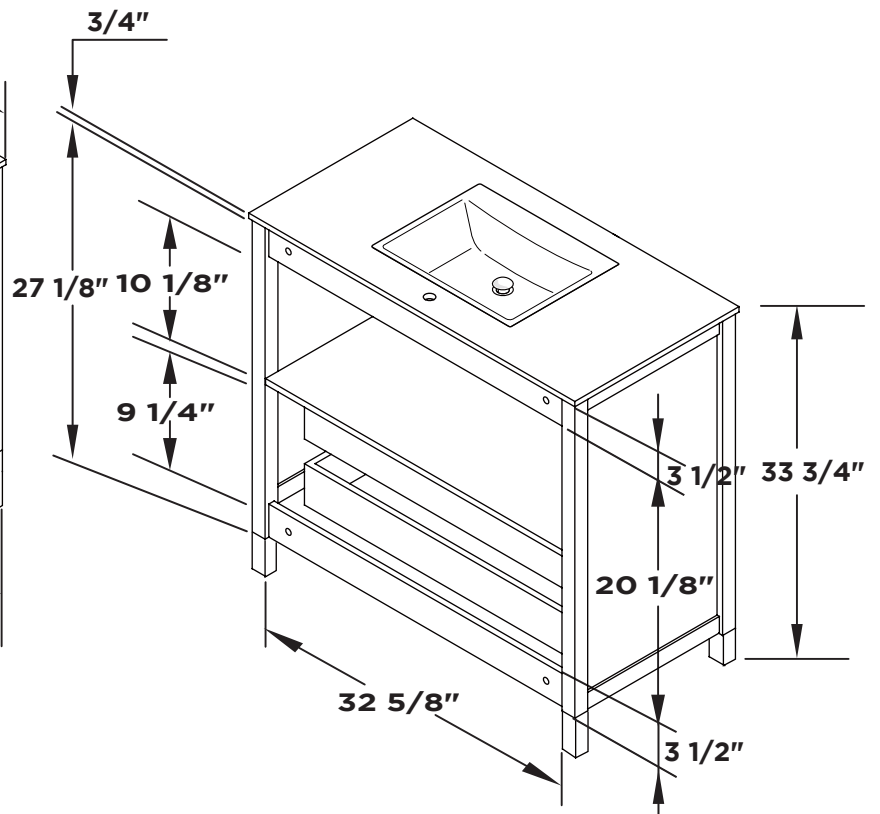

TOOLS FOR ASSEMBLY

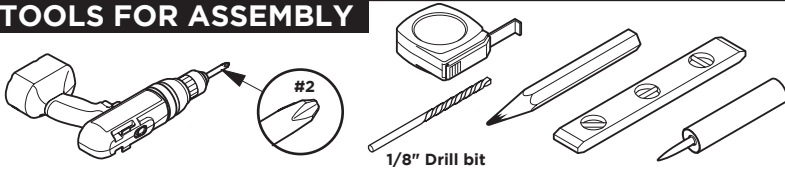

MIRROR INSTALLATION

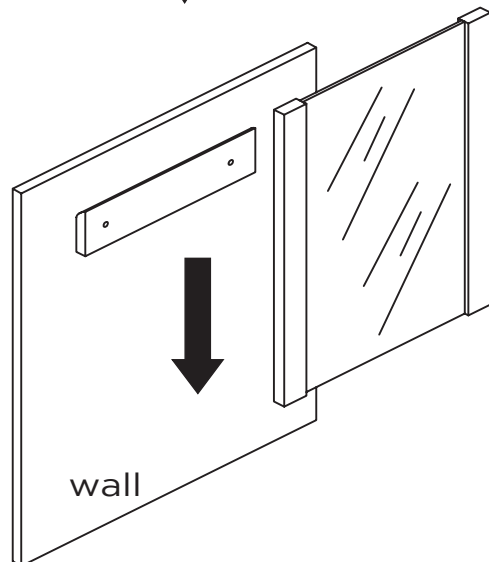
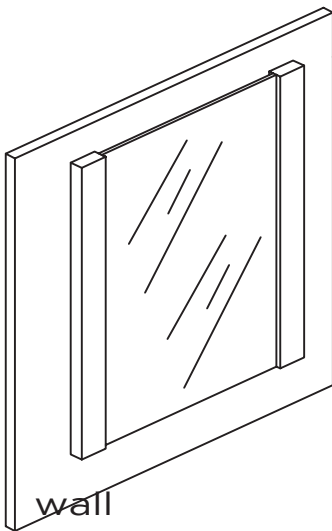
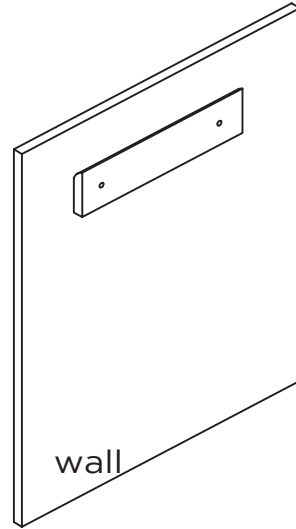
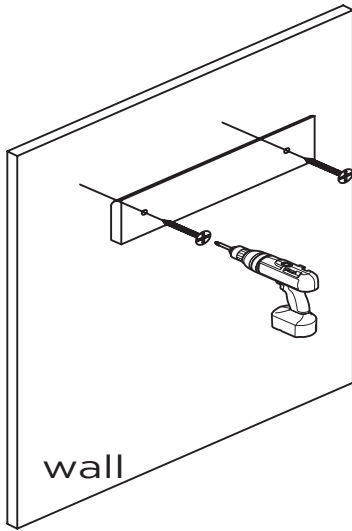

DRAWER REMOVAL & INSTALLATION

REMOVAL

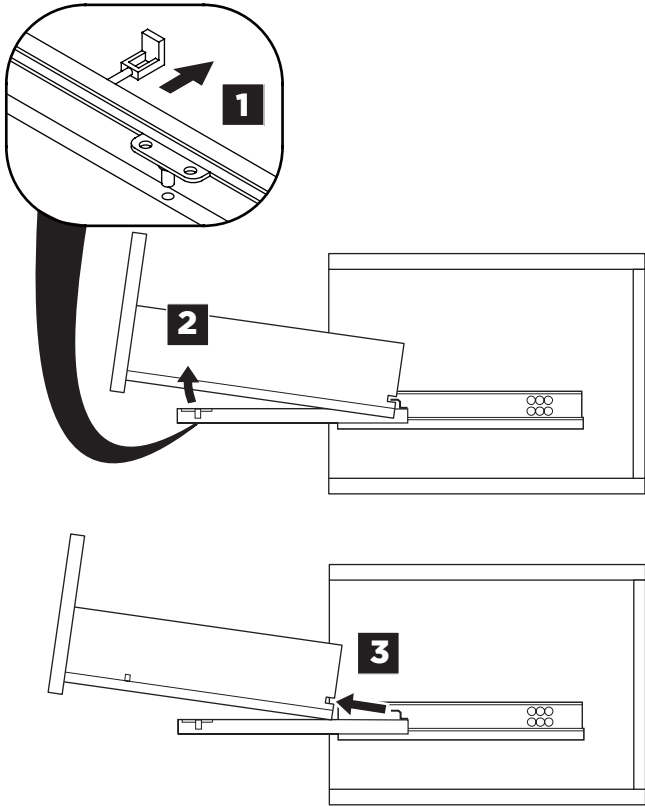

INSTALLATION

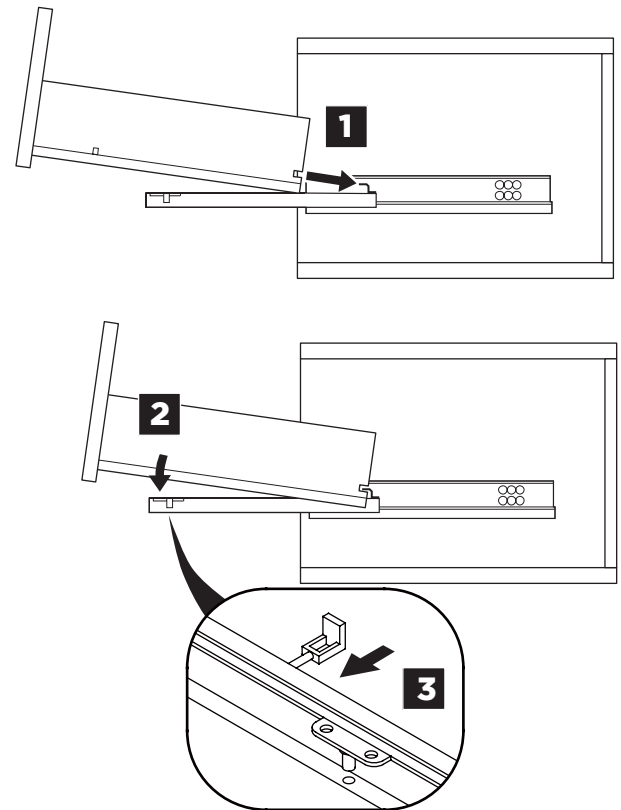

1 Install leg

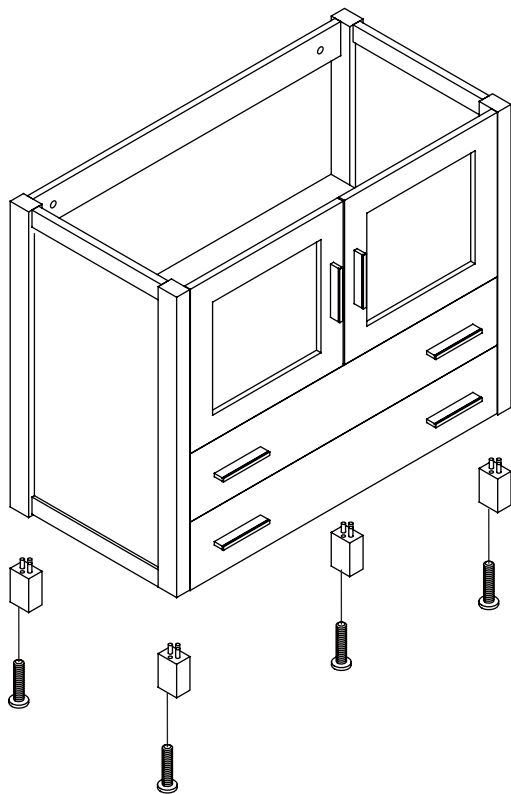

2 Remove drawer

3 Install cabinet

IMPORTANT: Consult an expert for the proper screws/bolts to use when attaching to various wall constructions. Screws provided do not attach to all wall construction types.

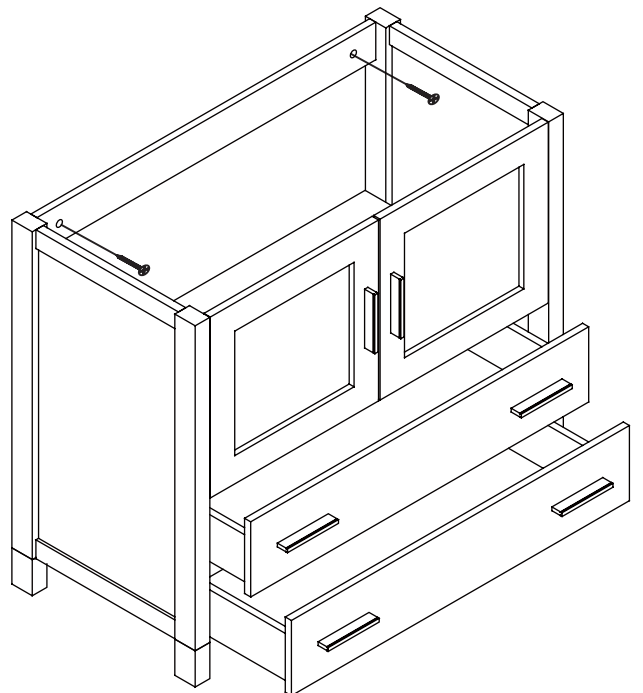

4

Install top panel

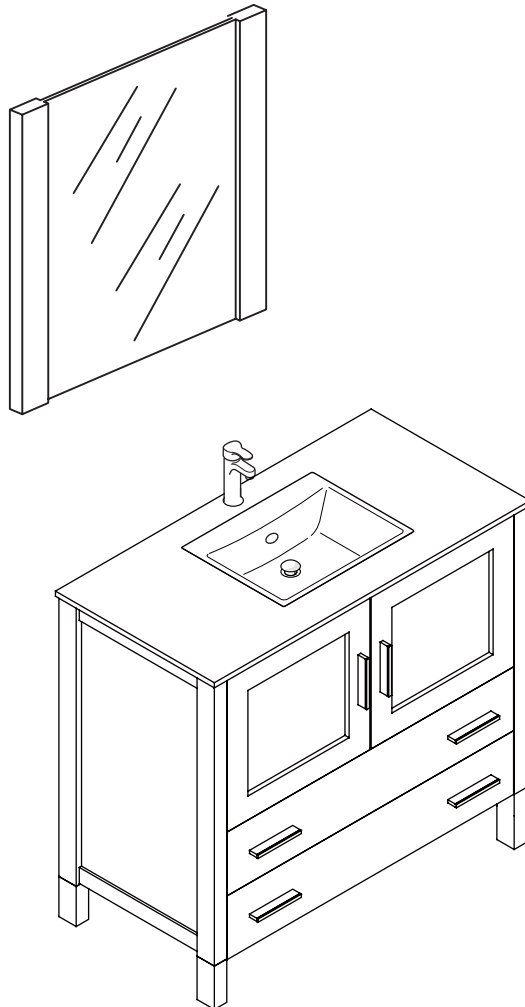
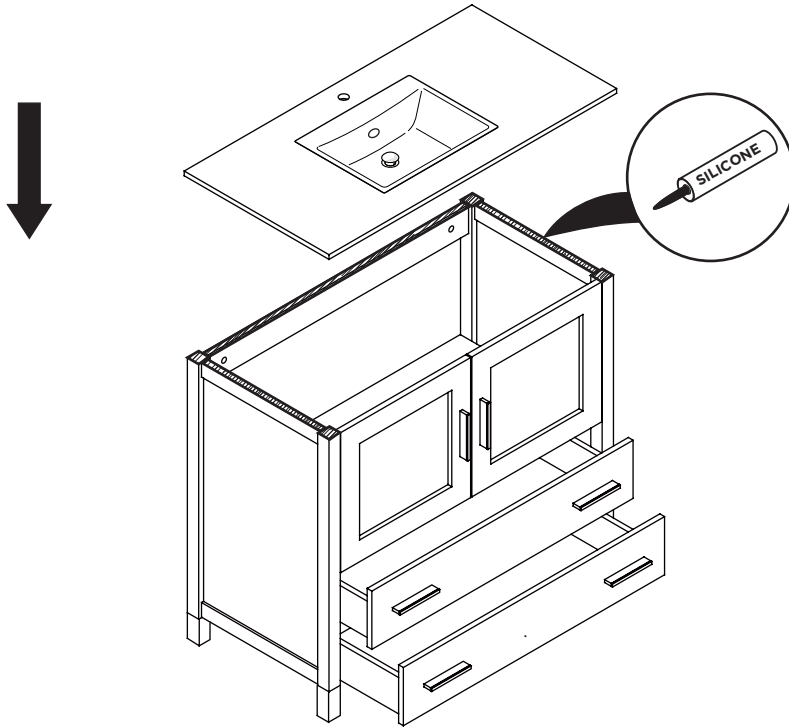

P-TRAP AND POP-UP INSTALLATION INSTRUCTIONS

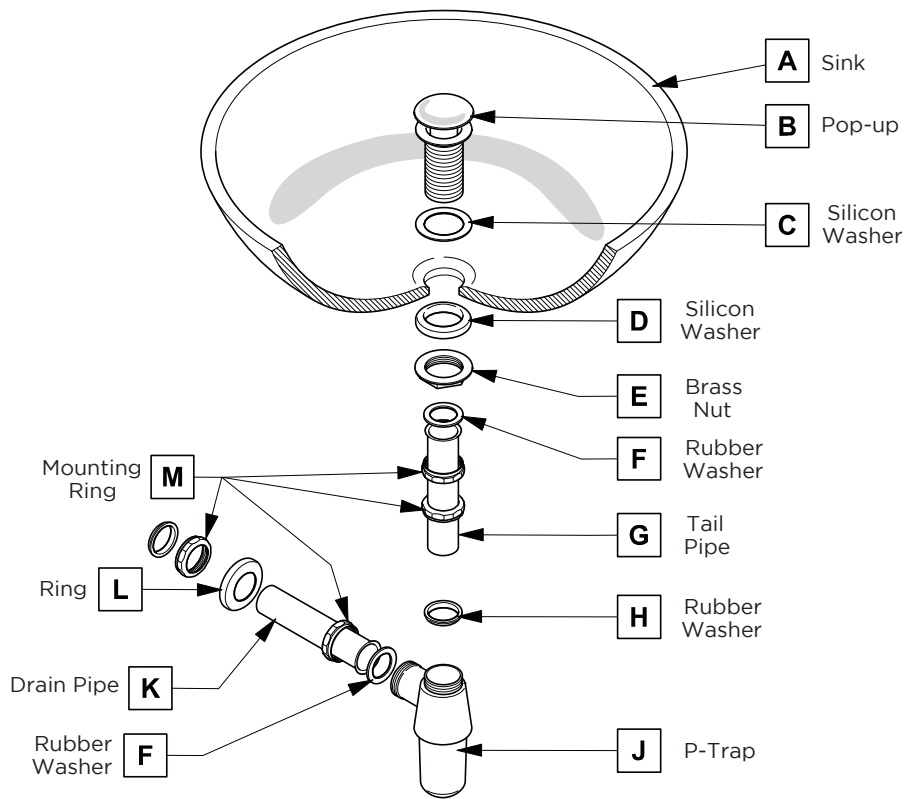

POP-UP INSTALLATION

FOR SINKS WITHOUT OVERFLOW

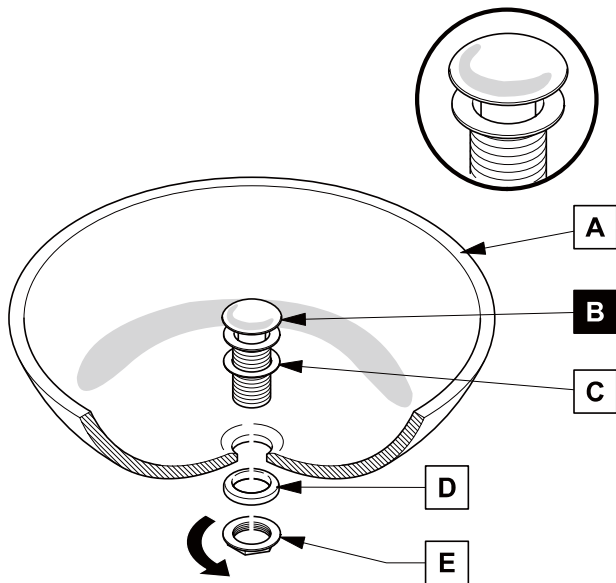

OR

FOR SINKS WITH OVERFLOW

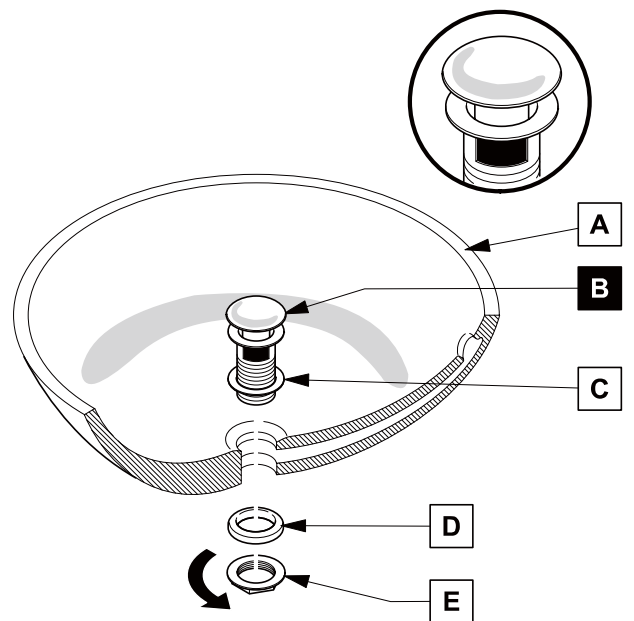

P-TRAP INSTALLATION

1

Install tail pipe (G)

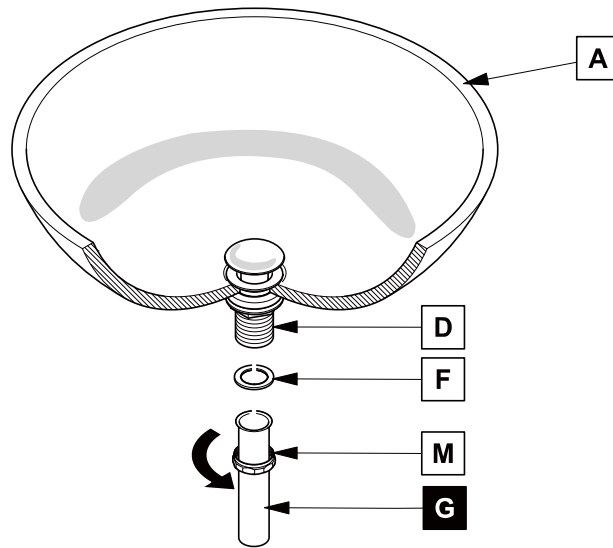

2

Install p-trap (J)

