



FVN8118

ALLIER

INSTALLATION GUIDE

CONTENTS:

Cabinet...(FCB8118).....	PAGE 3 (STEP 1)
Sink.....(FVS8118).....	PAGE 3 (STEP 2)
Mirror.....(FMR8118).....	PAGE 2

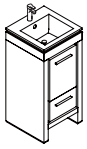

Mirror

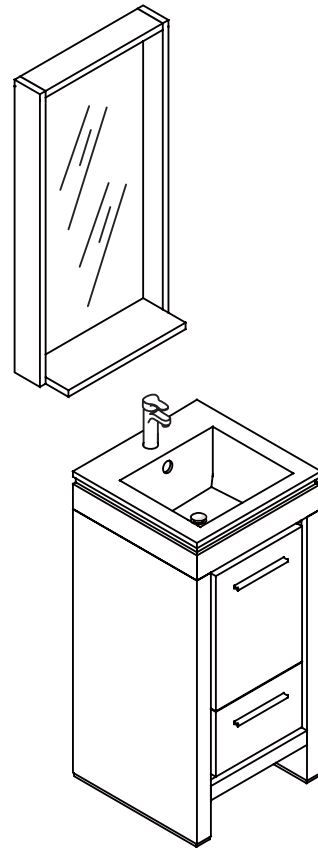
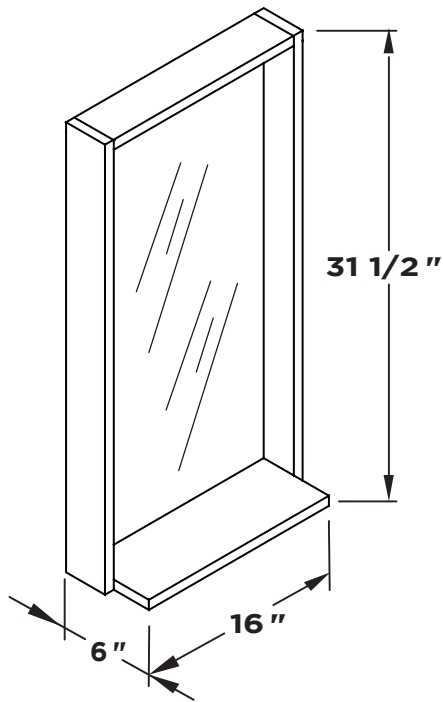

Vanity Front

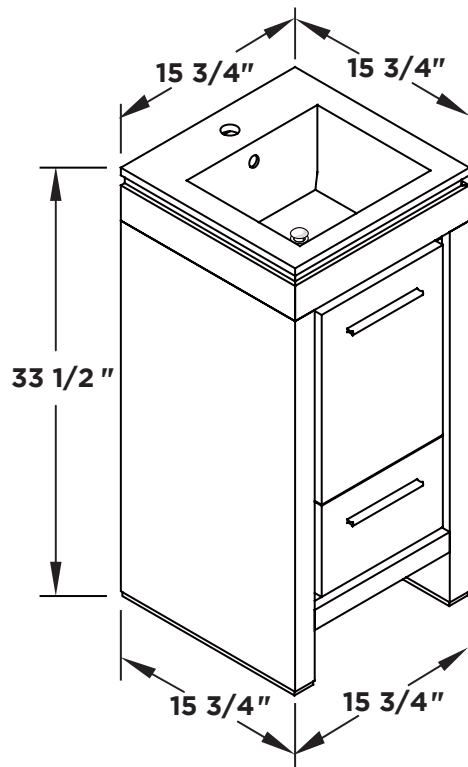

Vanity Back

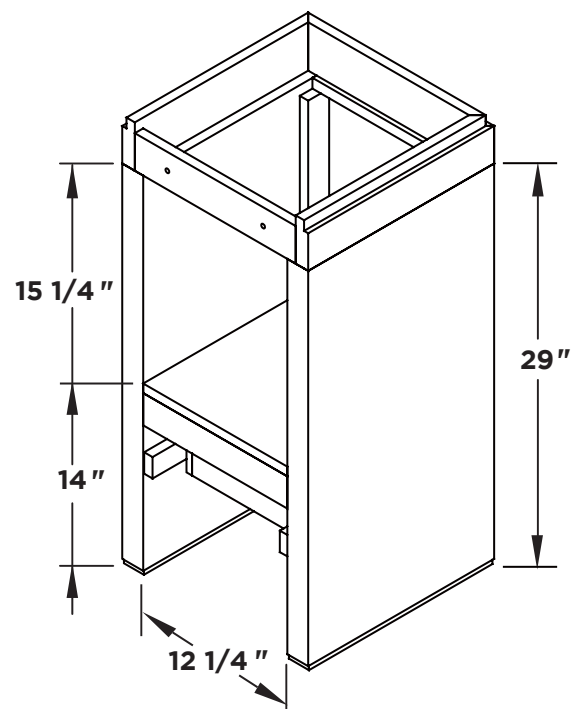

TOOLS FOR ASSEMBLY

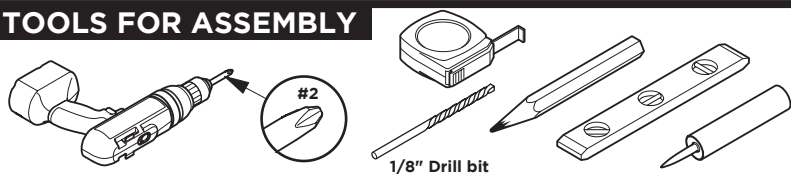

MIRROR INSTALLATION

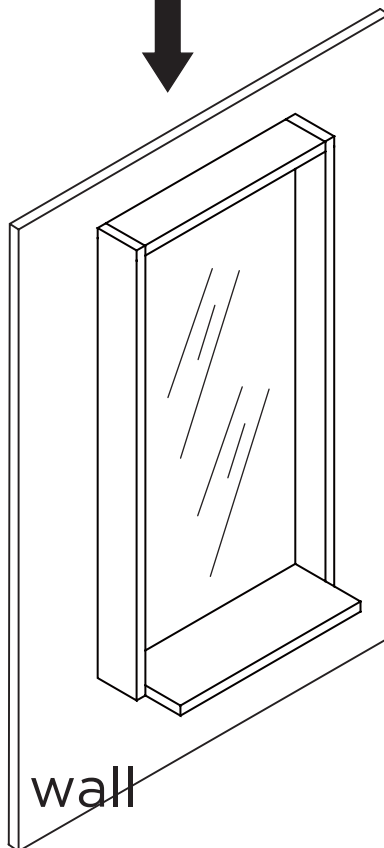
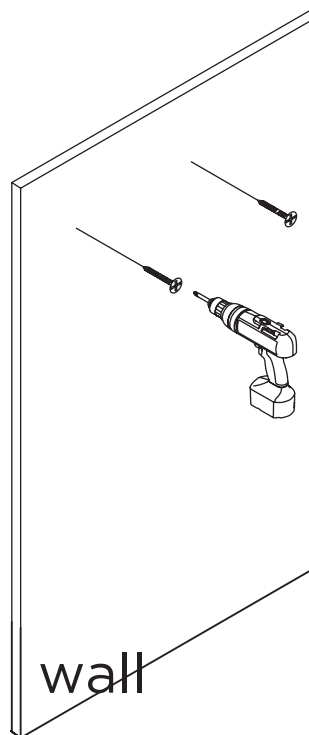
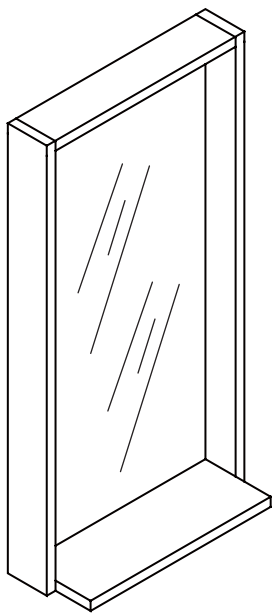

DRAWER REMOVAL & INSTALLATION

REMOVAL

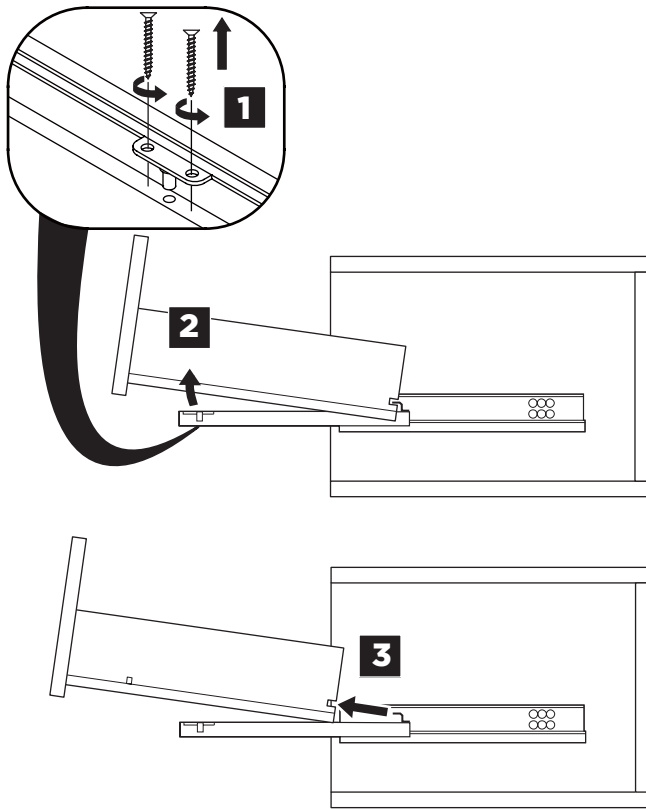

INSTALLATION

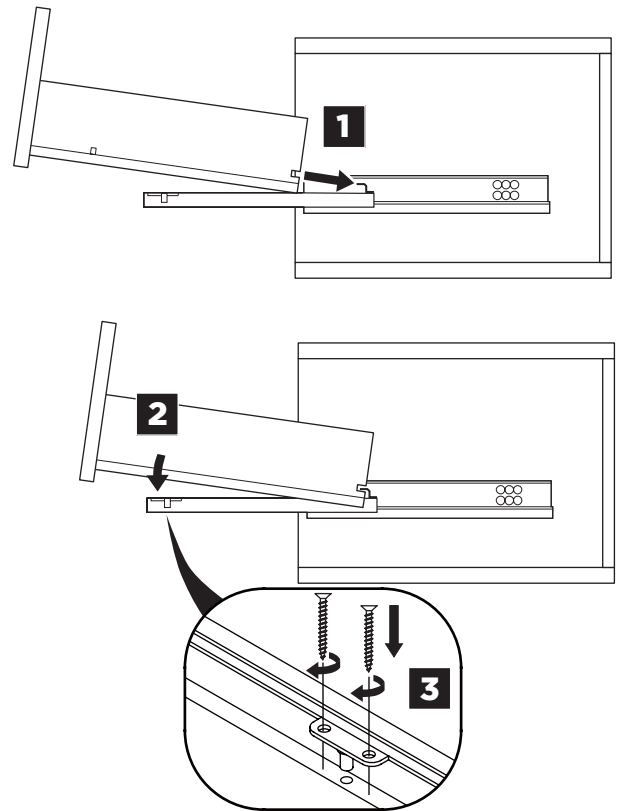

1

Remove drawer and open the door

IMPORTANT: Consult an expert for the proper screws/bolts to use when attaching to various wall constructions. Screws provided do not attach to all wall construction types.

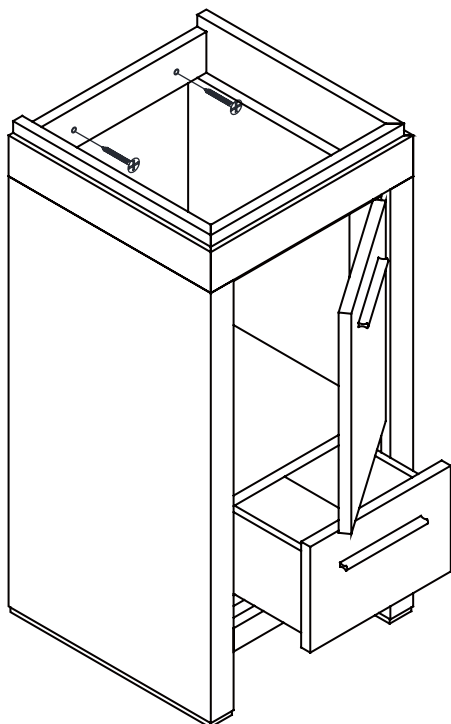

2

Install top panel

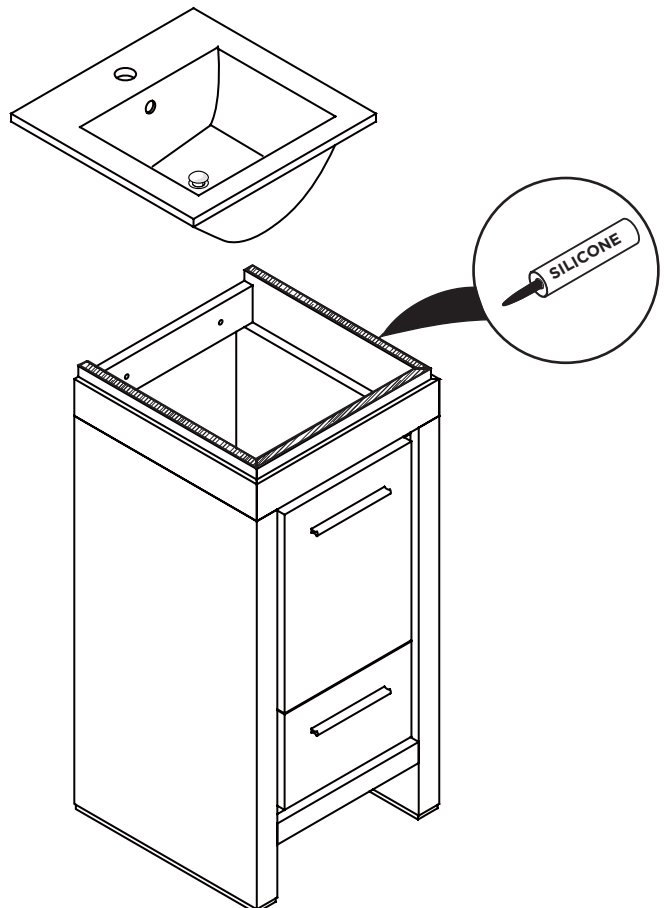

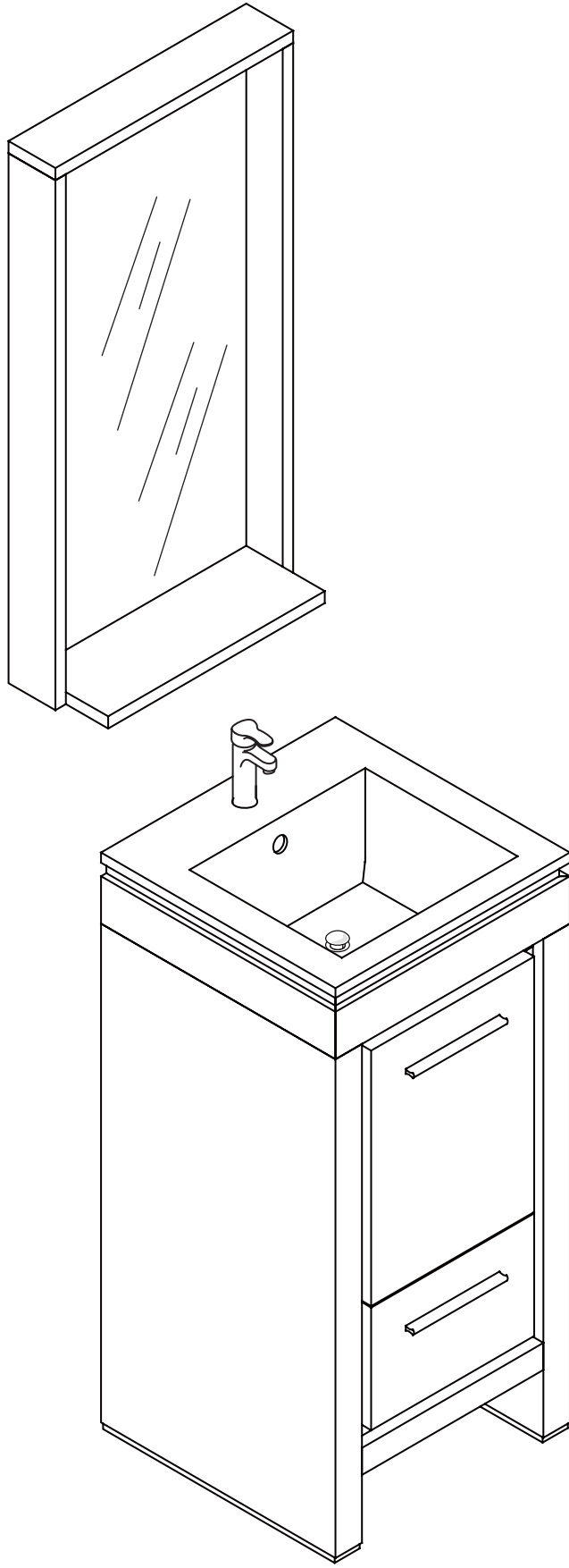

P-TRAP AND POP-UP INSTALLATION INSTRUCTIONS

Generic sink used for illustrations. Your sink may vary

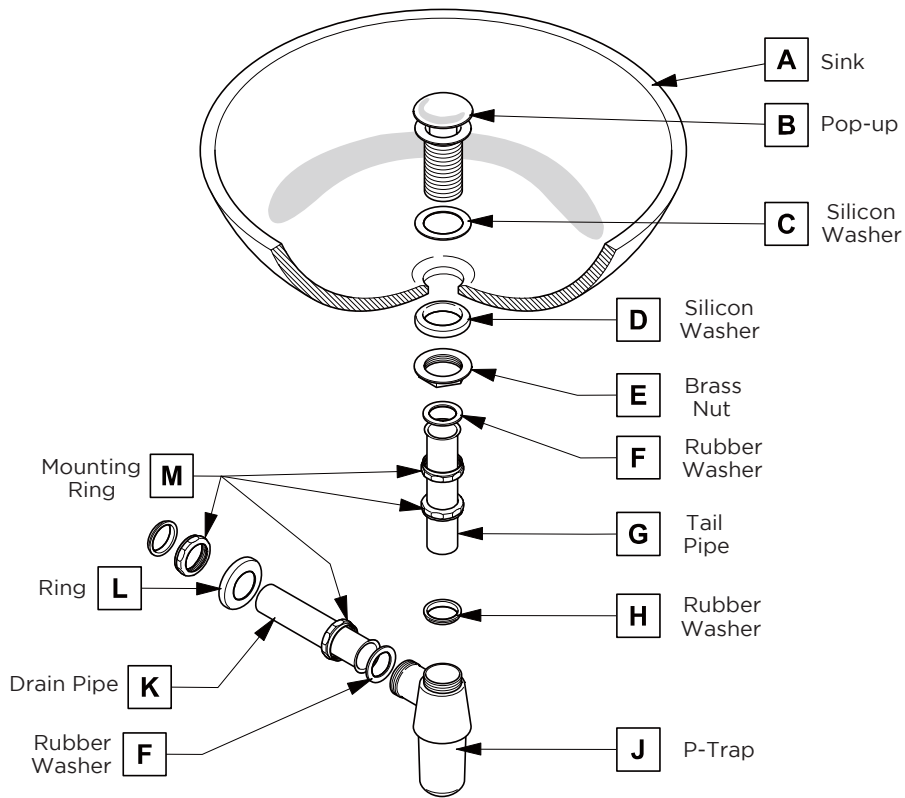

POP-UP INSTALLATION

FOR SINKS WITHOUT OVERFLOW

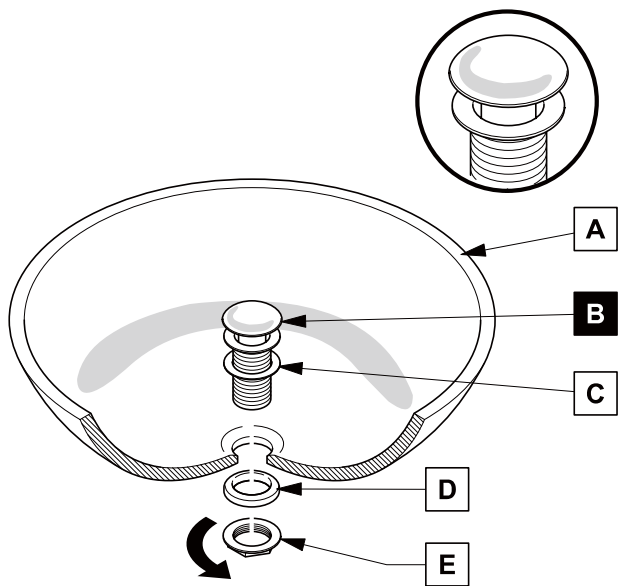

OR

FOR SINKS WITH OVERFLOW

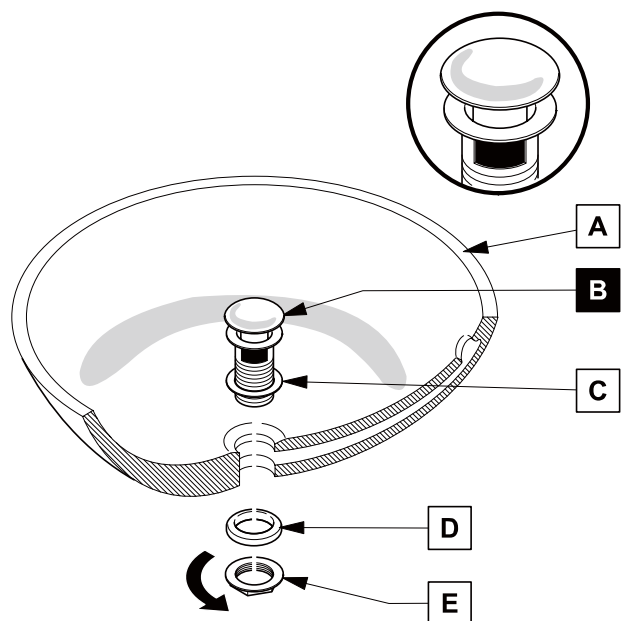

P-TRAP INSTALLATION

1

Install tail pipe (G)

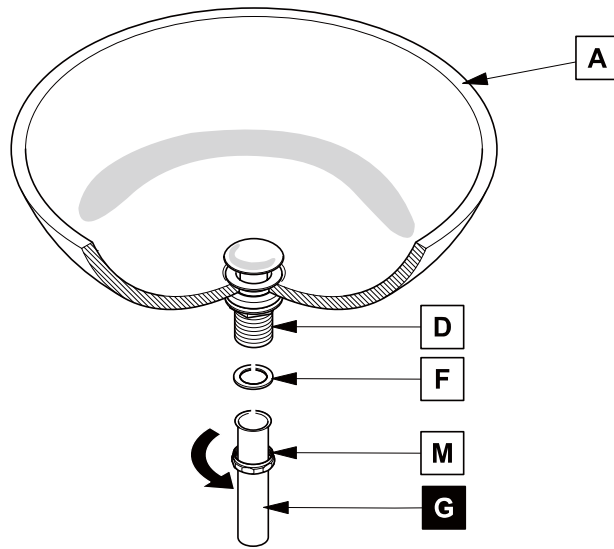

2

Install p-trap (J)

