

# Product Parts Breakdown

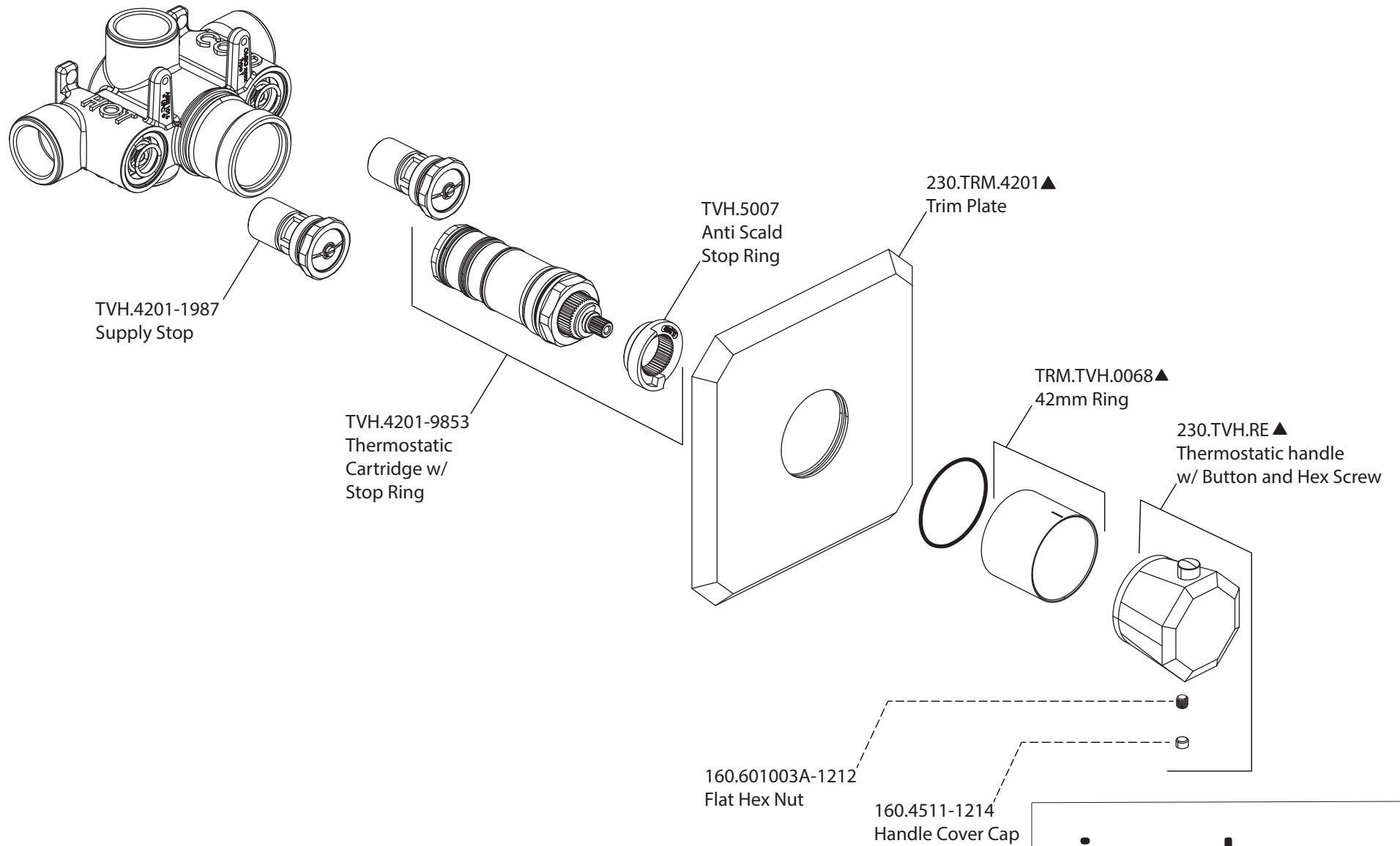

**isenberg**  
innovation+design

230.4201