

Product Parts Breakdown

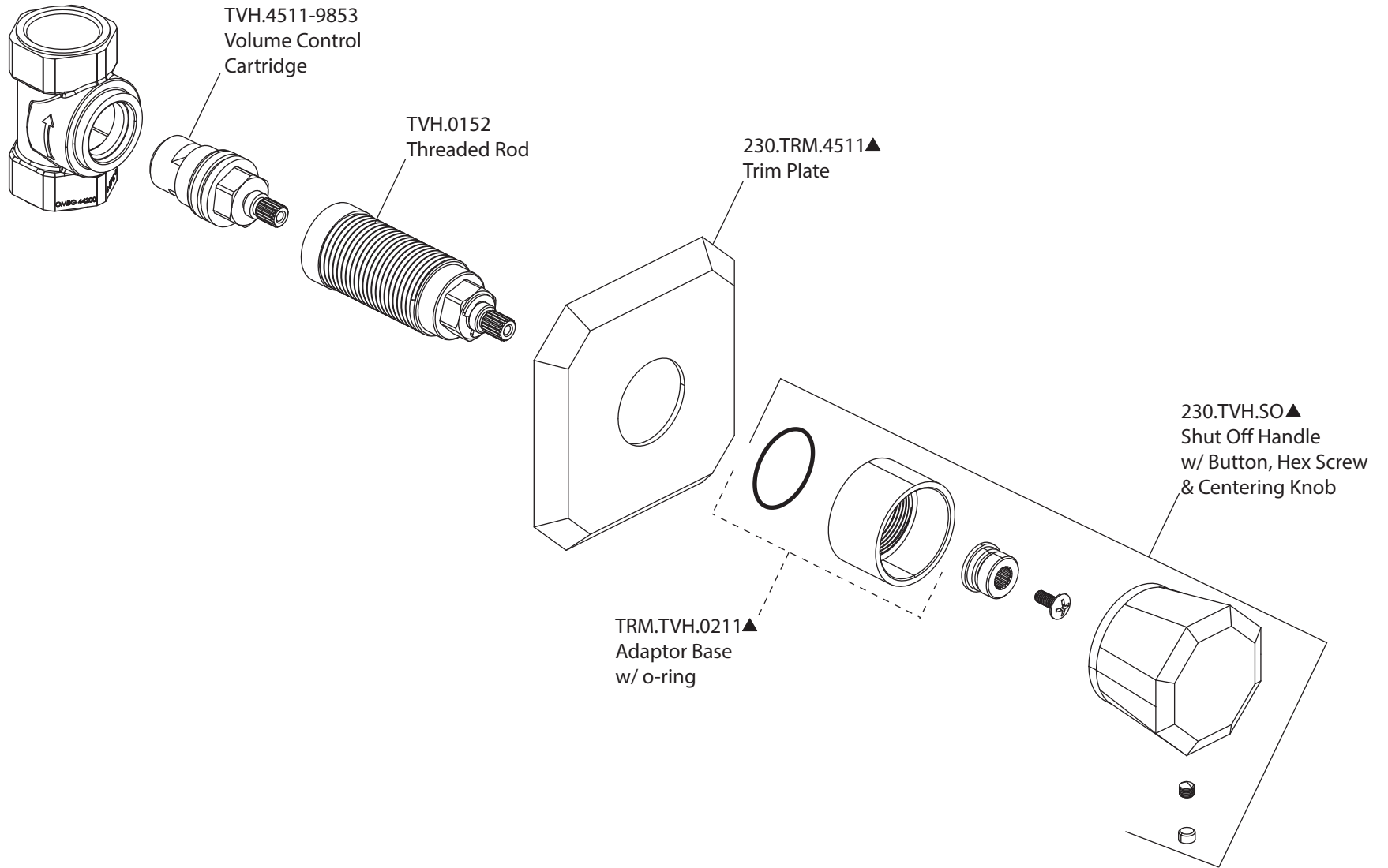

isenberg
innovation+design

230.4511