

Product Parts Breakdown

▲Specify Finish

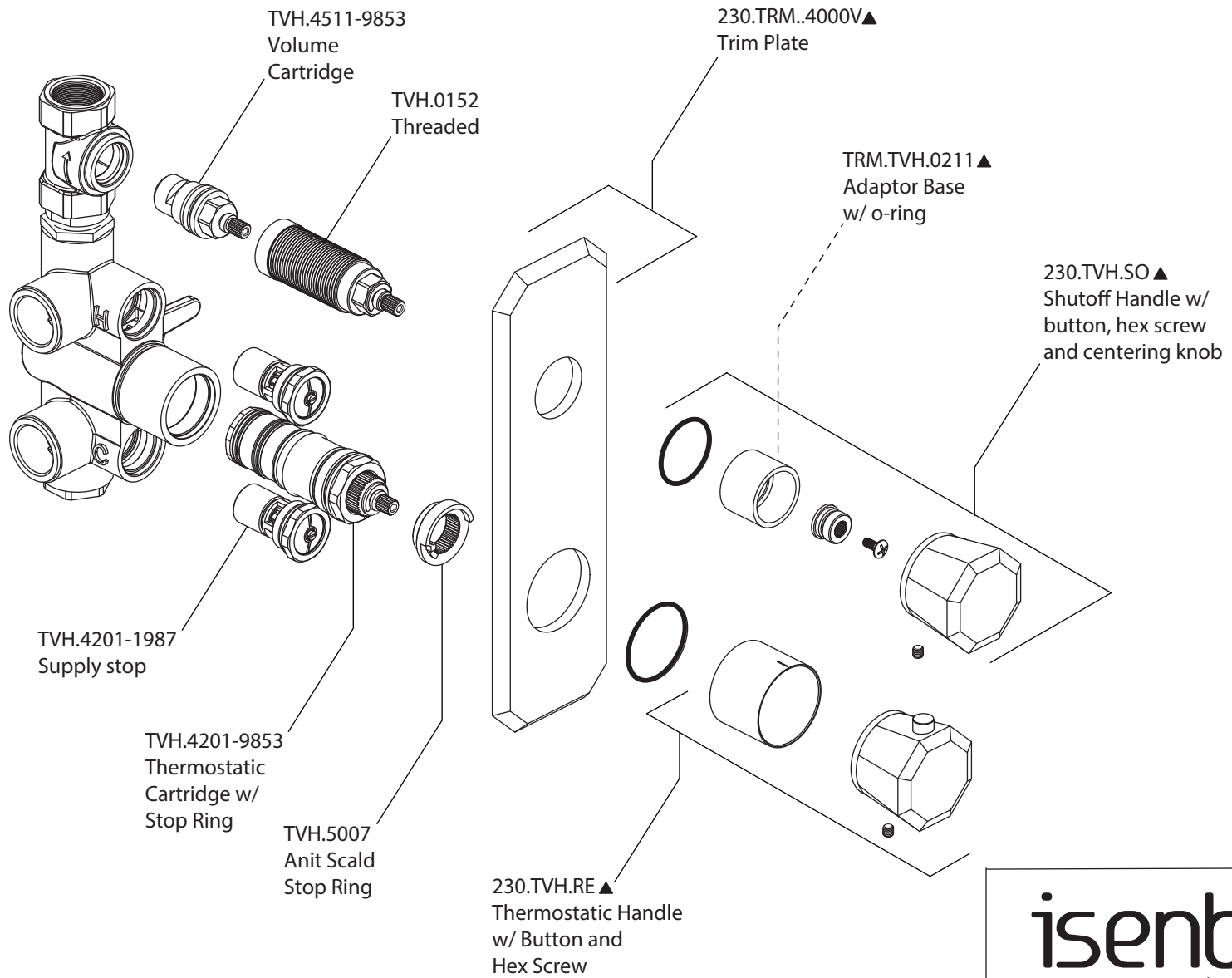

isenberg
innovation+design

230.2720

Ver 2.53