

# Product Parts Breakdown

▲Specify Finish

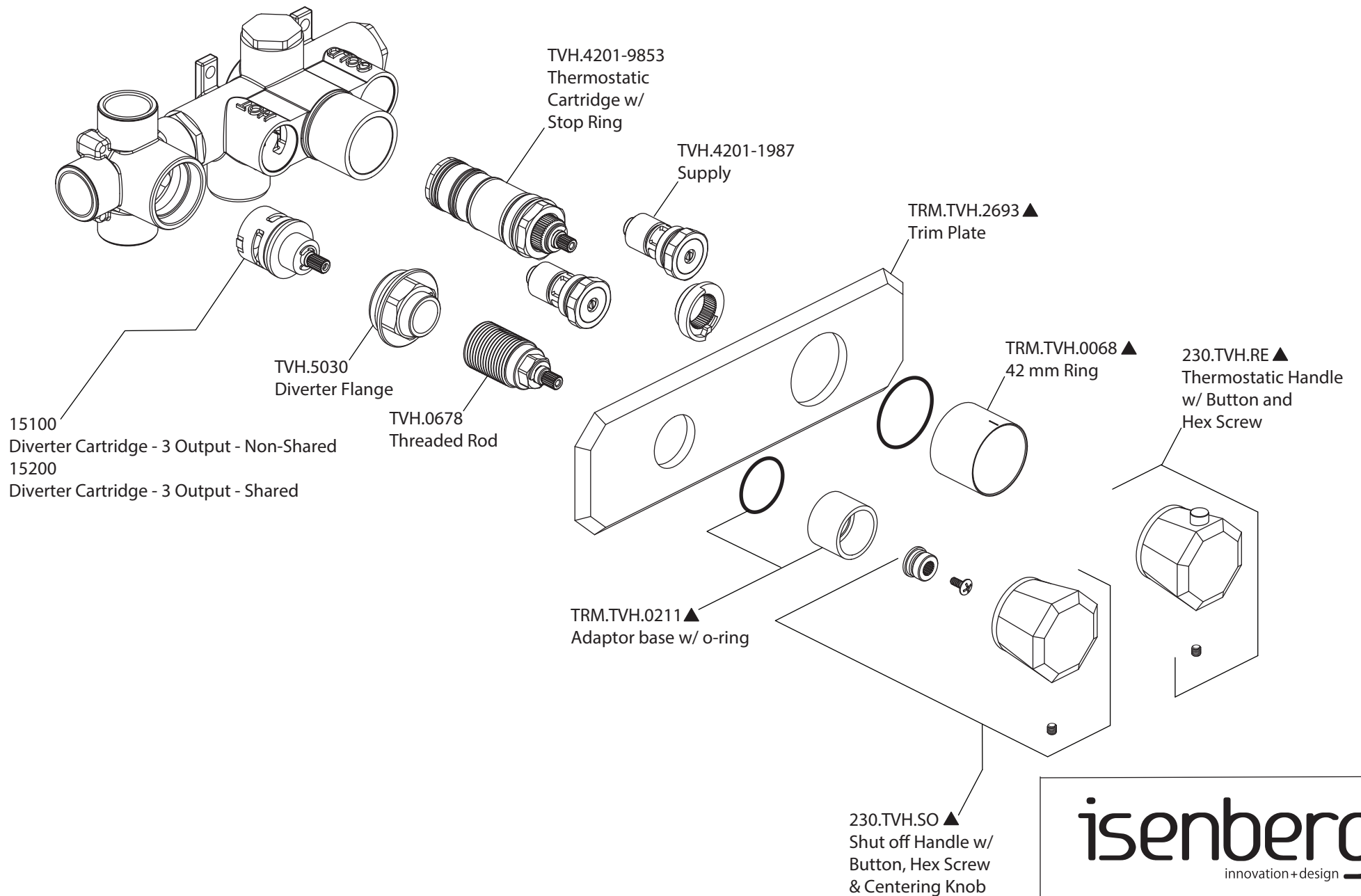

**isenberg**  
innovation+design

230.2705

Ver 2.55