

Product Parts Breakdown

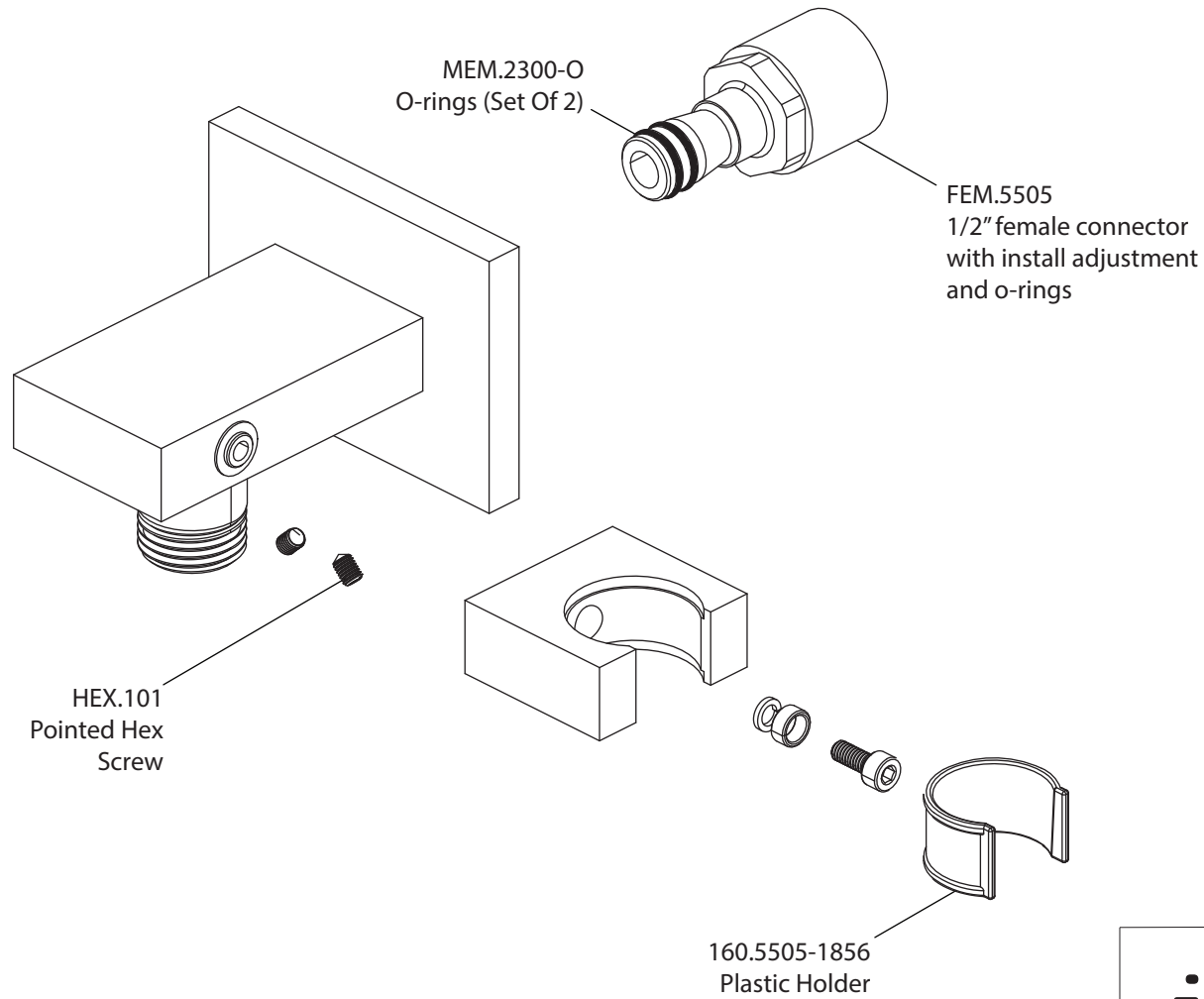

isenberg
innovation+design

HS8004

Ver 2.55