

## Installation Manual For 10.GGH.5007 180° Glass to Glass Hinge

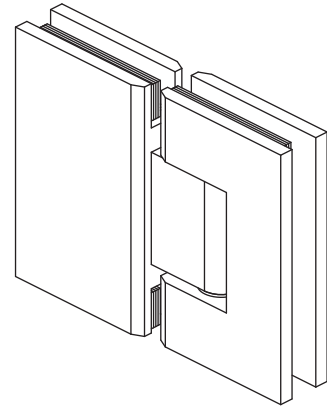

### NOTICE TO HOMEOWNER

- We recommend that this product is installed by a qualified professional plumber.
- Please check this product immediately to ensure that it has not been damaged and is complete. Before installation, please make sure this product is the correct model and you have all the parts required for installation and use.
- Please flush the water system to ensure that no metal swarf, solder, and other impurities can enter the product.
- Turn off water supply before commencing work.
- Please read these instructions carefully and retain for future reference.

### BEFORE YOU BEGIN

- You must observe all local plumbing laws and codes.
- Do not instal valve if it does not meet local plumbing codes.
- Shut off the main water supply.

## Installation Manual For 10.GGH.5007

### 180° Glass to Glass Hinge

#### TABLE OF CONTENTS

OPERATING SPECIFICATIONS . . . . .	3
INSTALLING HINGES . . . . .	5

## OPERATING SPECIFICATIONS

- **Glass Size:** 3/8" to 1/2" (10 to 12 mm) Tempered Glass only
- **Construction:** Solid Brass
- **Included:** Clamp body, glazing gaskets, mounting screws, and fabrication template
- **Use:** Residential Bath Commercial Hotel Applications

## TECHNICAL DRAWING

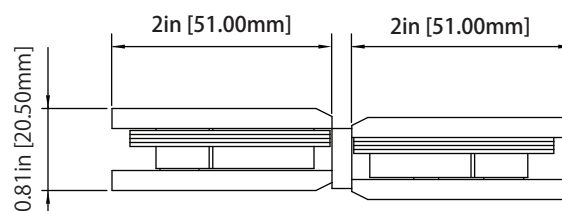
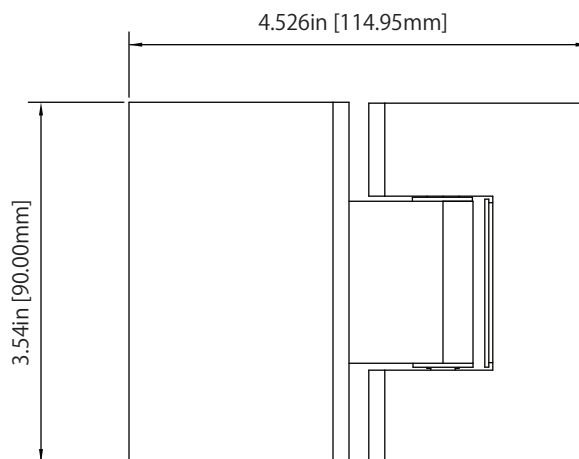

## SPECIFICATION

### • GASKET SPECIFICATIONS:

For 3/8" (10mm) Glass: Use One Thick Gasket On Each Side  
For 1/2" (12mm) Glass: Use One Thick Gasket On Each Side

### • GASKET INSTRUCTIONS:

Only use tempered safety glass, To prevent damage to the clamp finish  
During Installtion, do not use power tools when installing these clamps.

### • CARE & CLEANING GUIDELINES:

For best result, keep the following recommendations in mind when caring for you shower door hardware. Your shower door hardware should be dried daily with a soft towel or cloth to insure its original finish.

Do not use harsh cleaners or chemicals on the hardware, as many of the components are coated with a clear lacquer that will become damaged beyond repair.

Always test your cleaning solution in an inconspicuous area prior to cleaning the entire hardware surface.



Wipe surfaces clean using a soft dampened cloth or sponge and rinse completely with warm water immediately after applying the cleaning solutions.

Use only small amount of liquid, gentle cleaner.

Never use abrasive products, sponges, or wire scrub brushes while cleaning hardware.

### • MAINTENANCE:

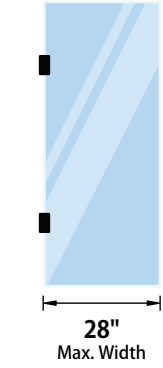
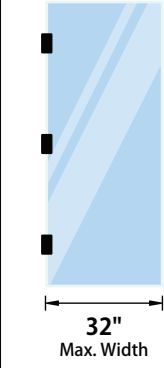
Hinges come factory greased for a silent, hassle-free experience. If there is any noticeable squeaking that occurs after installation, it is recommended to apply a few drops of (3 in 1) multi-purpose oil to the hinge, at the nylon washer/pivot location. The lubricant will penetrate the hinge crevices, reducing friction, cleaning grime, and/or build up. Spray lubricants are prohibited. If, for some reason, the hinge is disassembled during maintenance, use a small amount of white lithium grease to lubricate the interior hinge components.

2-HINGES	3-HINGES
	
	

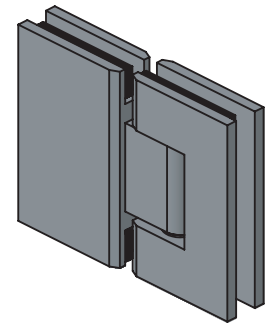

FRONT ISO VIEW

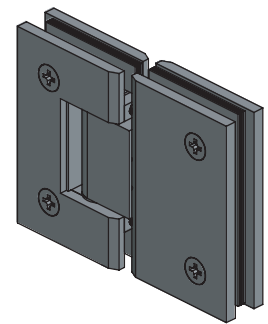

REAR ISO VIEW

## INSTALLATION

### Glass Cutout Details

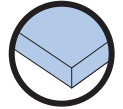

**USE ONLY  
MONOLITHIC  
TEMPERED GLASS**

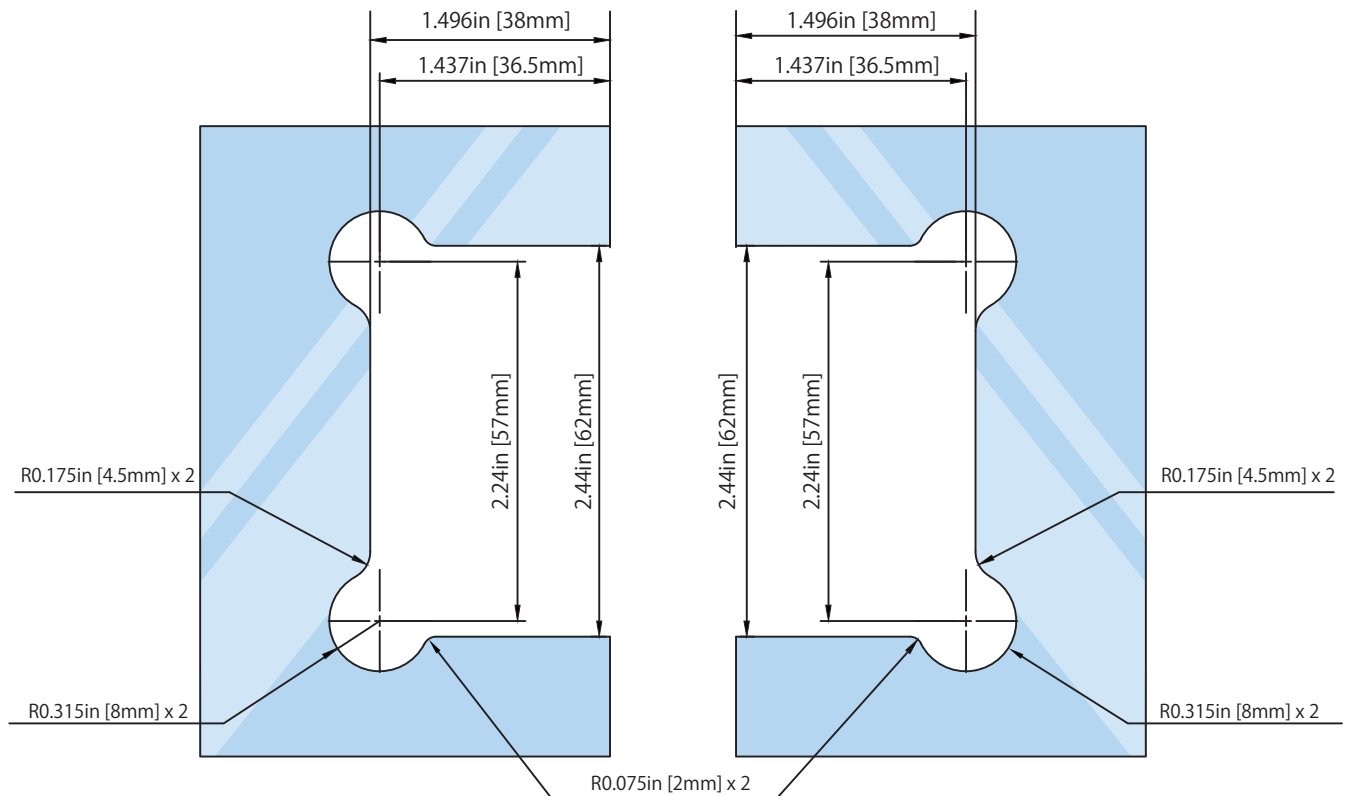

Tolerance :  $\pm 0.1$   
Glass Thickness: 3/8in [~10mm] to 1/2in [~12mm]

MAXIMUM DOOR CAPACITY	3/8" (10 mm) GLASS Approx. 4.06 lb/ft <sup>2</sup>	1/2" (12 mm) GLASS Approx. 6.4 lb/ft <sup>2</sup>
	DOOR WEIGHT	DOOR WIDTH
USING 2 HINGES	80 LBS. (36.3 kg)	28" (711 mm)
USING 3 HINGES	120 LBS. (54.4 kg)	32" (813 mm)

**NOTE:** Please ensure that you do not surpass either the maximum weight or width limitations when determining the appropriate quantity of hinges needed.

## INSTALLATION

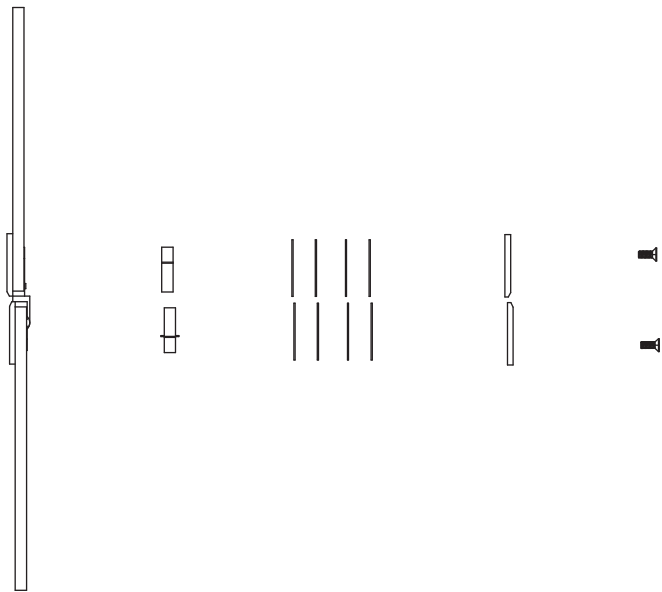

TOP EXPLODED VIEW-1

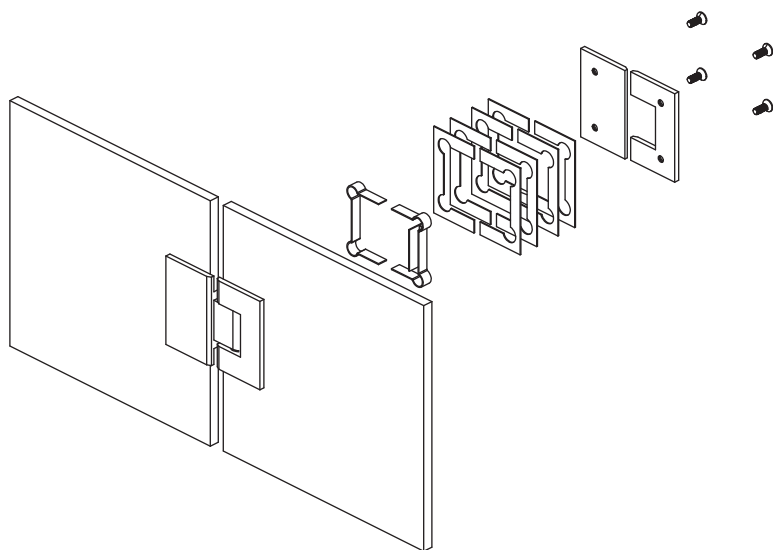

ISO EXPLODED VIEW-2

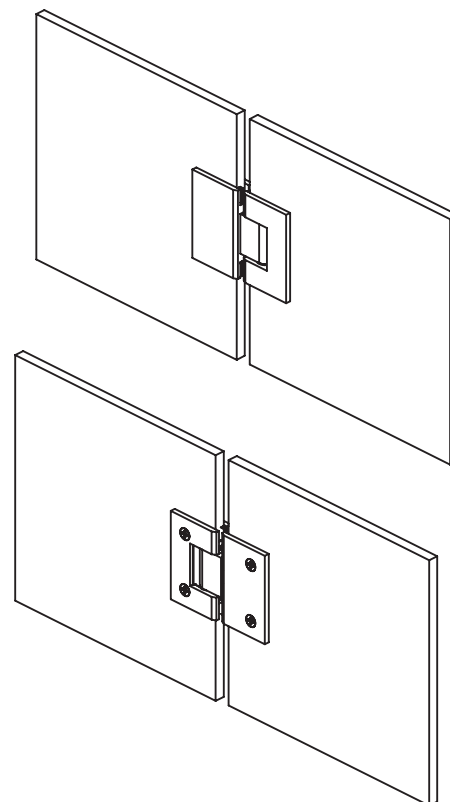

ISO VIEW-3