

10.WGH.5016 | Wall to Glass Hinge

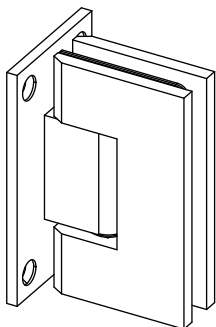

SPECIFICATIONS:

- Solid Brass construction
- Fits 3/8" to 1/2" Thick Glass
- Max Door Weight for 2 Hinges: 110lbs
- Max Door Weight for 3 Hinges: 140lbs
- Includes: Hinge body, glazing gaskets, allen head/phillips head cover plate screws, and fabrication template
- Self-close within 15° of closing position

GASKET SPECIFICATIONS :

- For 3/8"~10mm Glass: Use One Thick Gasket On Each Side
- For 1/2"~12mm Glass: Use One Thin Gasket On Each Side

GLASS INFO :

- Use on tempered safety glass only. Avoid using power tools to prevent damage to Hinge body.



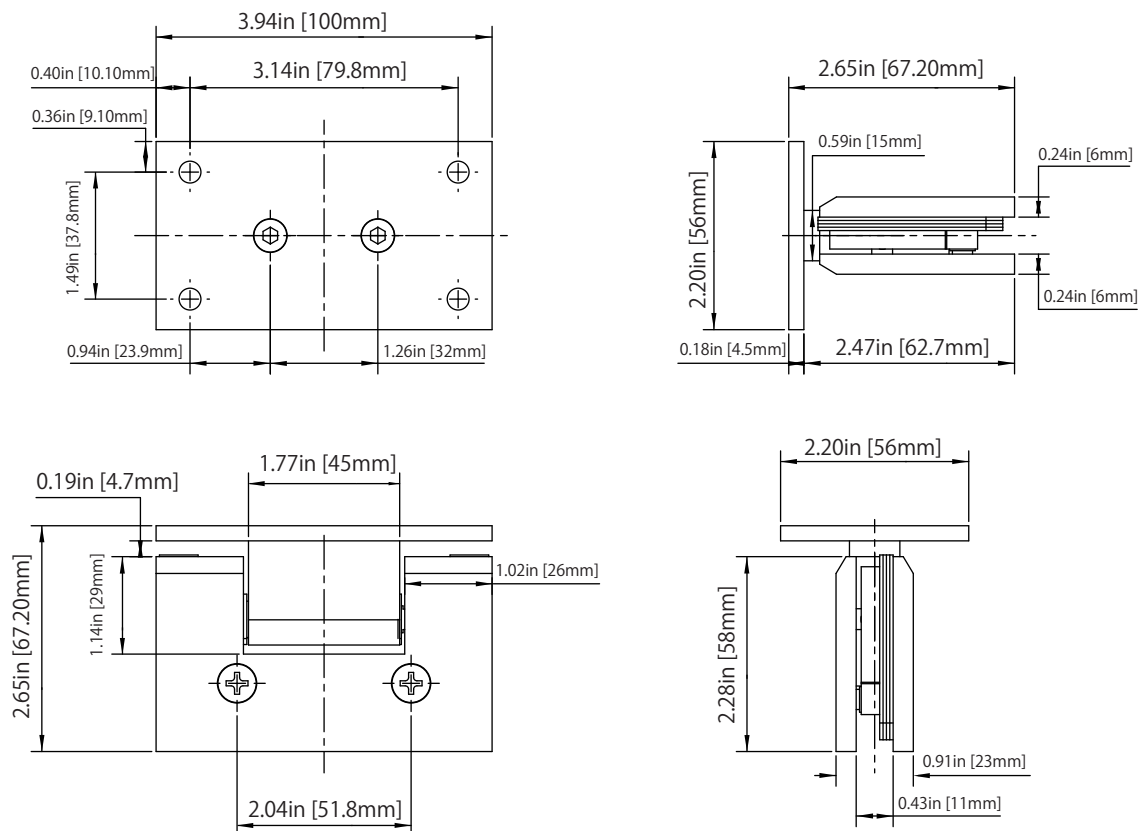

Technical Diagram



IMPORTANT INFORMATION :

MAXIMUM DOOR CAPACITY	3/8" (10 mm) GLASS Approx. 4.06 lb/ft ²	1/2" (12 mm) GLASS Approx. 6.4 lb/ft ²
	DOOR WEIGHT	DOOR WIDTH
USING 2 HINGES	110 LBS. (50kg)	36" (914 mm)
USING 3 HINGES	140 LBS. (63 kg)	36" (914 mm)

NOTE: Please ensure that you do not surpass either the maximum weight or width limitations when determining the appropriate quantity of hinges needed.

2-HINGES	3-HINGES
	
36" Max. Width	36" Max. Width
	

GLASS CUTOUT DETAILS

Wall to Glass Hinge
Item No: 10.WGH.5016

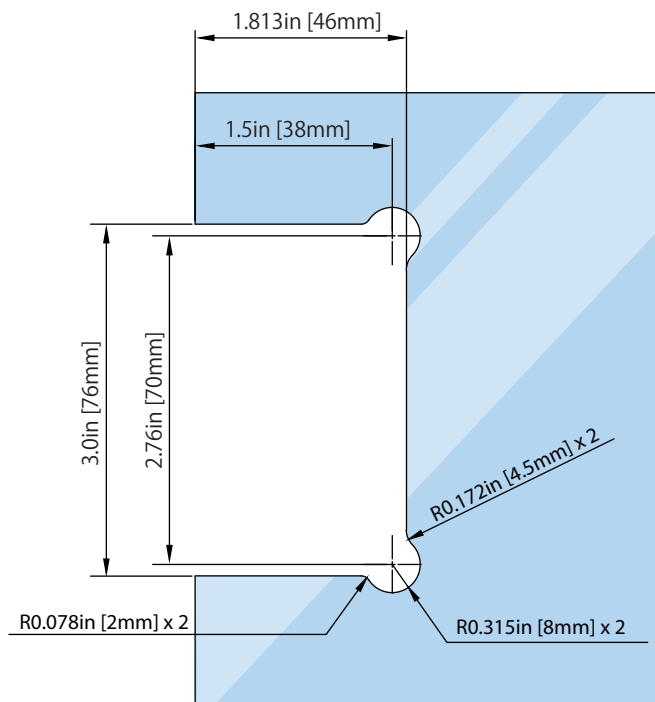

Tolerance : ± 0.1
Glass Thickness: 3/8in [~10mm] to 1/2in [~12mm]

CARE & CLEANING GUIDELINES:

For optimal maintenance of your shower door hardware, adhere to the following guidelines:

- Regularly dry your shower door with a soft towel or cloth to preserve its original finish.
- Avoid using harsh cleaners or chemicals on the hardware, as the components may be coated with a clear lacquer that can incur irreparable damage.
- Prior to cleaning the entire hardware surface, conduct a patch test with your chosen cleaning solution in an inconspicuous area.
- Clean surfaces with a soft, dampened cloth or sponge, and thoroughly rinse with warm water after applying a small amount of gentle cleaning solution.
- Under no circumstances should abrasive products, sponges, or wire scrub brushes be used during the cleaning process.

MAINTENANCE :

- Hinges are supplied pre-greased at the factory to ensure a quiet and trouble-free operation.
- Should any squeaking become noticeable post-installation, it is advisable to apply a few drops of multi-purpose oil to the hinge, specifically at the nylon washer/pivot location. This lubricant will effectively permeate the hinge crevices, reducing friction and removing any accumulated grime or debris.
- Please refrain from using spray lubricants. In the event that the hinge needs to be disassembled for maintenance purposes, a small amount of white lithium grease should be applied to lubricate the interior hinge components.

FRONT VIEW

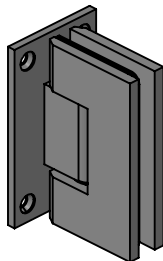

REAR VIEW

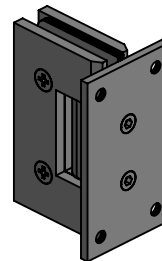

FIT REPRESENTATION

