

Product Parts Breakdown

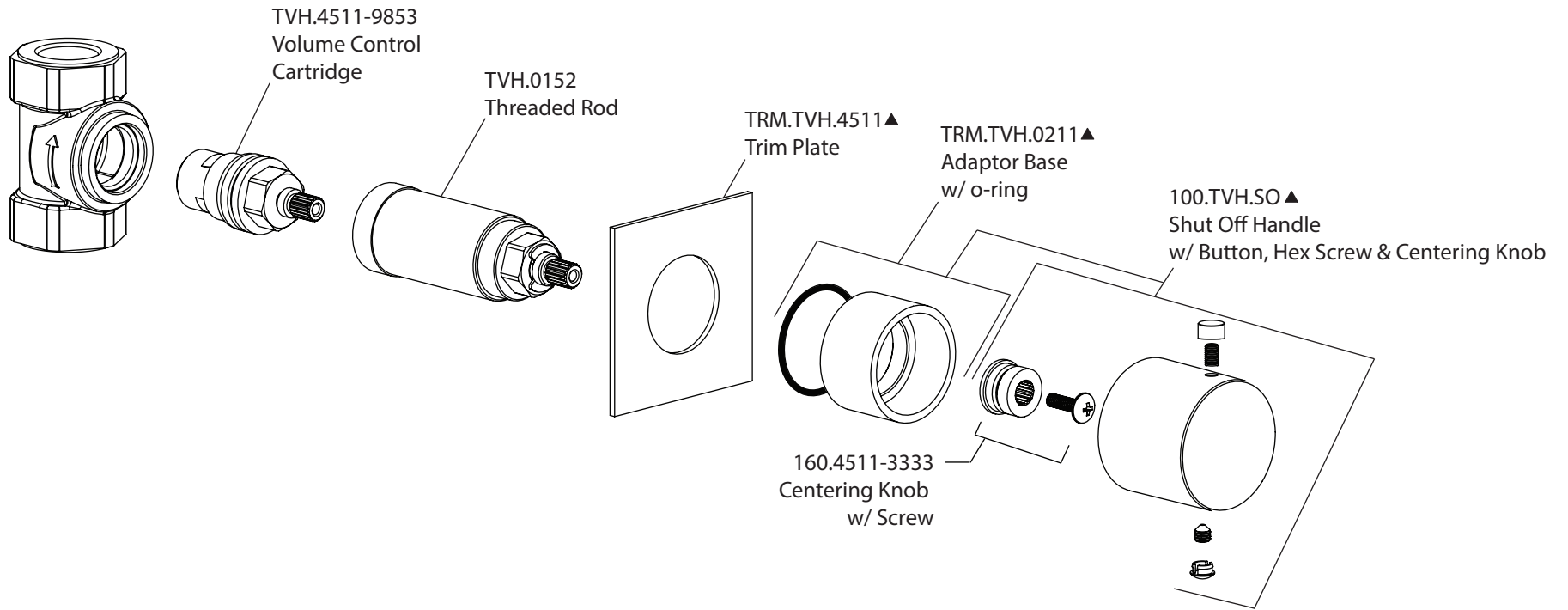

Model No. 100.4511

Ver 2.55