

100.7150 | Two Output Shower W/ Rain Head & Hand Held

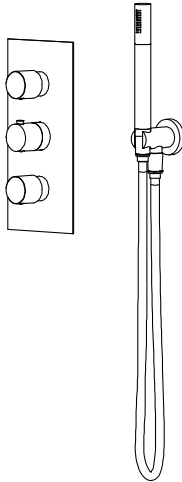
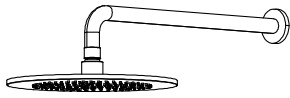

COMPONENTS

- HS1012SA - 16" Shower Arm
- HSB.10R - 10" Shower Head
- 100.4401T - Shower Trim
- TVH.4401 - Shower Valve
- HS1004H - Hand Held
- HS8008 - Wall Elbow w/ Holder
- SP.150EM - 1.5m Hose

SHOWER VALVE:

- Thermostatic shower valve
- Valve includes service stops
- Bottom handle controls handheld.
- Top handle controls shower head
- Middle handle controls temperature
- Shared port operation

SHOWER HEAD:

- Solid brass construction
- 1.8 GPM flow rate

HAND HELD:

- Solid Brass construction
- 1.8 GPM flow rate
- 1/2" female NPT connection
- With back flow prevention check valve

STANDARDS:

- ASME A112.18.1 / CSA B125.1

See individual component specification sheets on following pages for further details.

HS1012SA | Round Shower Arm - 400mm - 16"

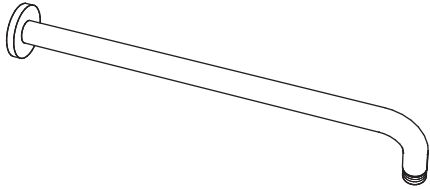

SPECIFICATIONS:

- Solid Brass Shower Arm
- With Sliding Flange

Technical Diagram

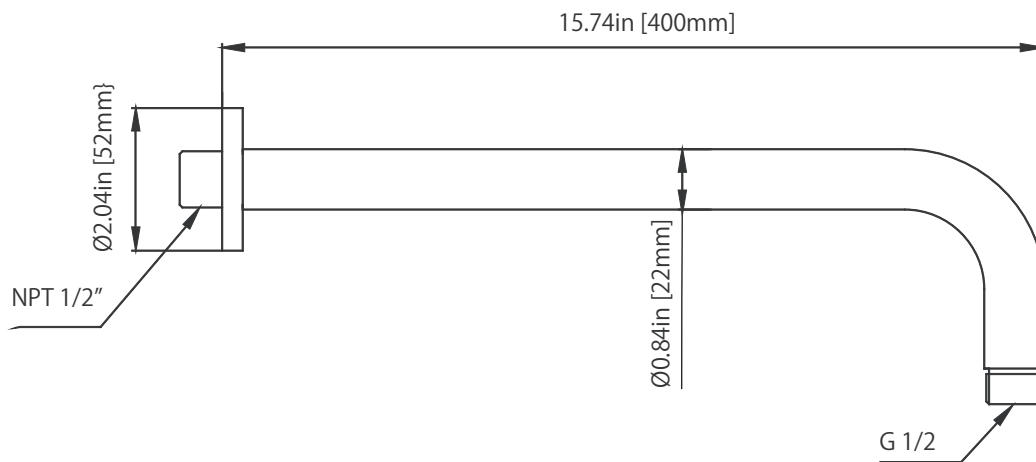

HSB.10R | 10" Brass Shower Head

SPECIFICATIONS:

- Solid Brass Shower Head
- Scrub rubber nozzles to easily clean water sediment
- 1.8 GPM Flow Rate
- 121 Nozzles

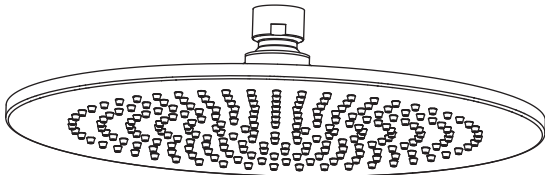

Technical Diagram

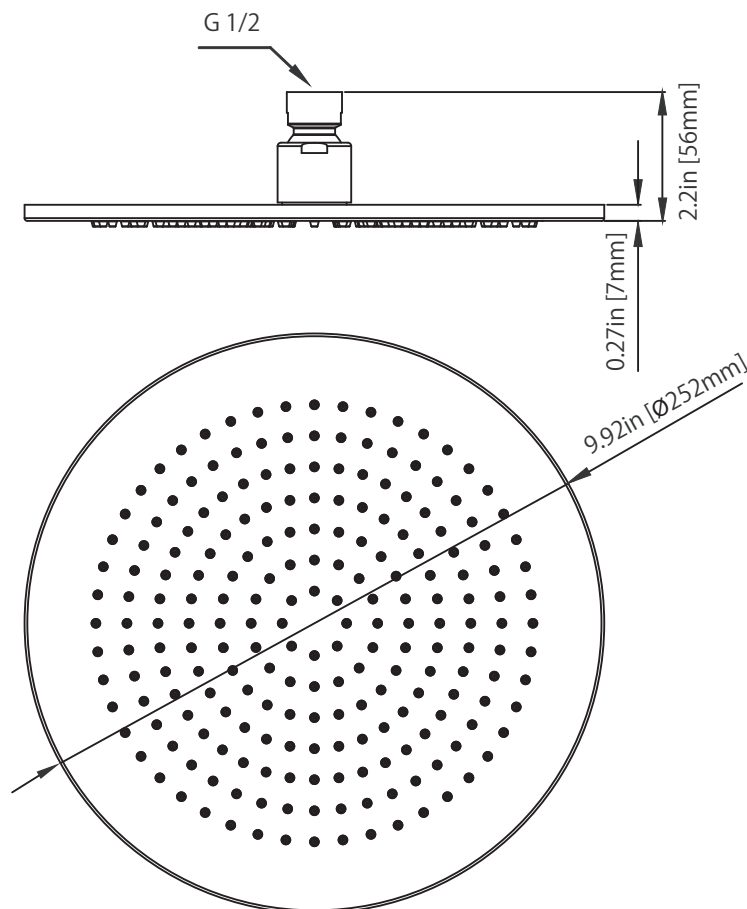

100.4500T | Three Handle Thermostatic Trim

SPECIFICATIONS:

- Solid Brass construction
- Trim only - valve not included
- Turn middle knob to control temperature.
- Turn top knob to divert water flow between two top outlets.
- Turn bottom knob to control water flow of bottom outlet.

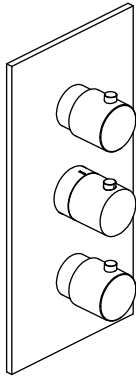

Technical Diagram

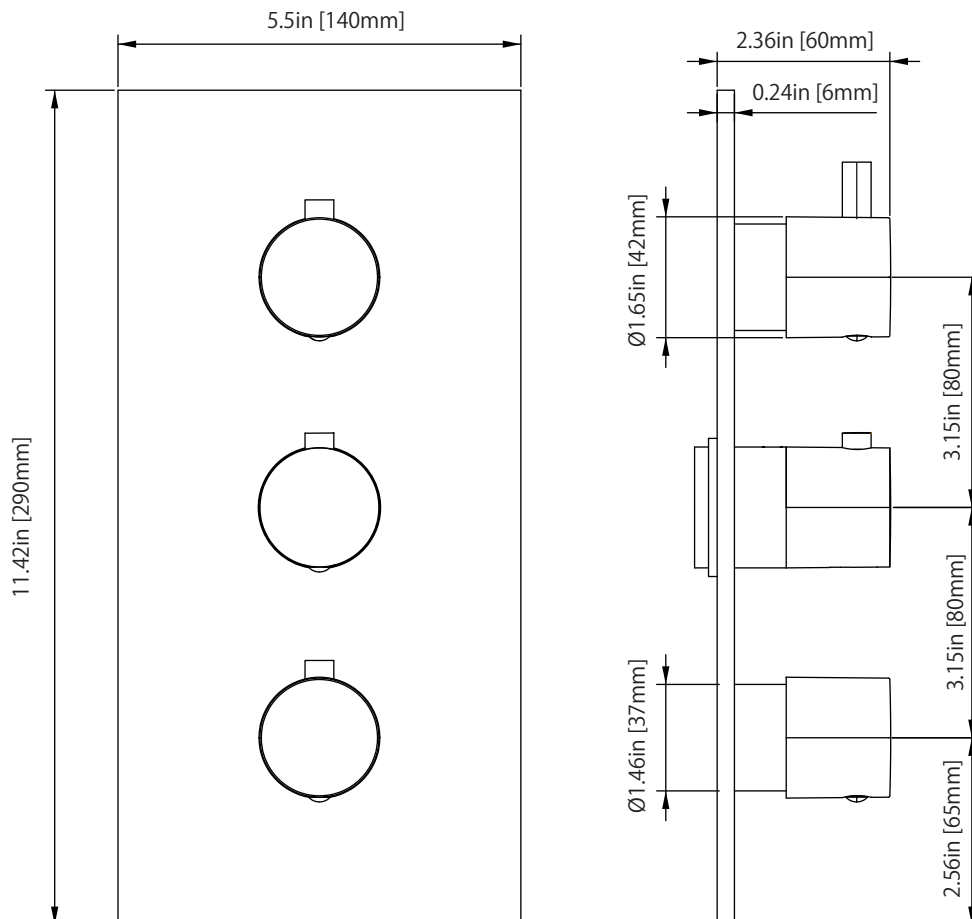

TVH.4401 | 3/4" Thermostatic Valve With 2 Independent Volume Controls Page 1 of 2



SPECIFICATIONS:

- Turn middle knob to control temperature.
- Turn top knob to control water flow from top output.
- Turn bottom knob to control water flow from bottom output.
- Thermostatic Valve Flow Rate - 13.0 GPM @ 60 PSI
- Extension Available - TVH.4401E**

STANDARDS:

- ASME A112.18.1 / CSA B125.1

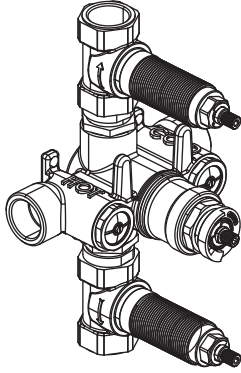

Technical Diagram

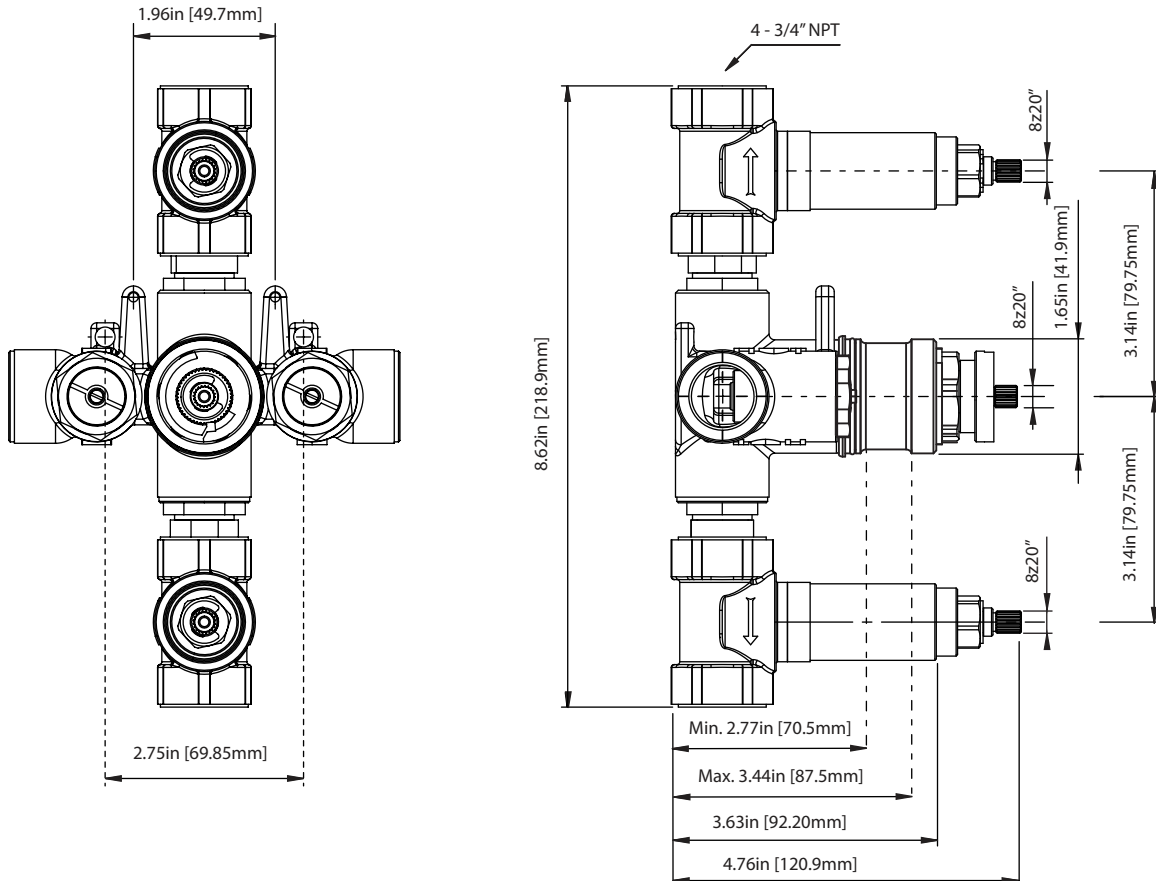

TVH.4401 | 3/4" Thermostatic Valve With 2 Independent Volume Controls



Water Flow Diagram

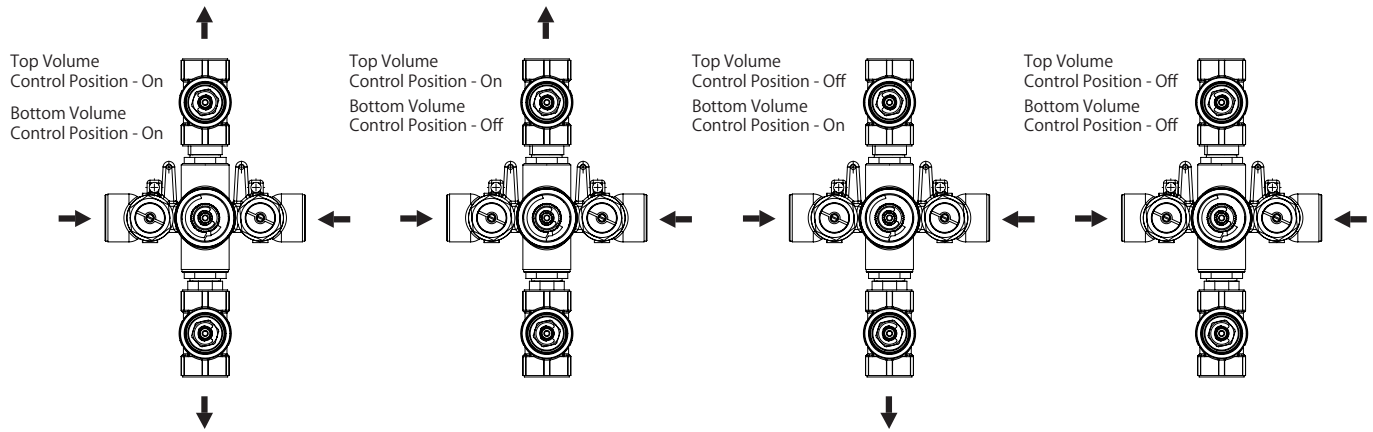

HS1004H | Solid Brass Hand Shower

SPECIFICATIONS:

- Solid Brass Construction
- 1.8 GPM Flow Rate
- With back flow prevention check valve



Technical Diagram

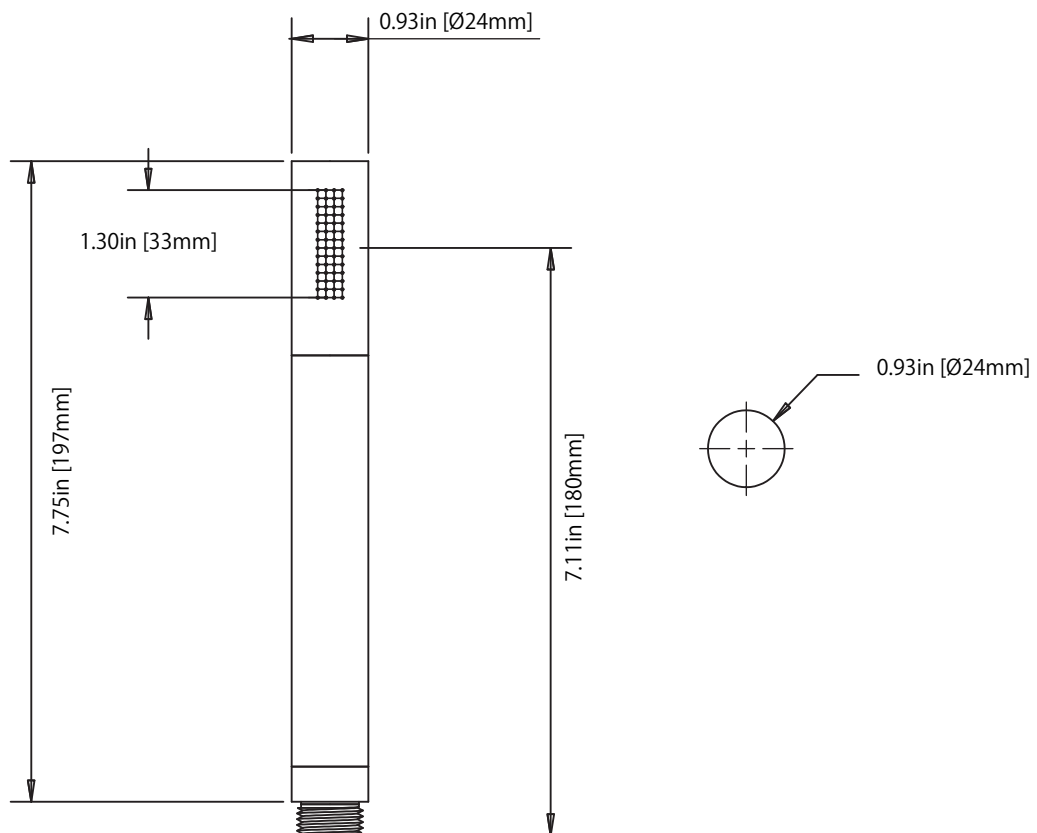

HS8008 | Wall Elbow With Holder Combo

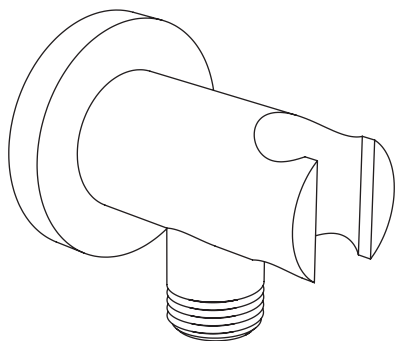

SPECIFICATIONS:

- Solid Brass construction
- Includes check valve with back flow prevention.

FAST SHIP FINISHES :

- Chrome - HS8008CP / Brushed Nickel - HS8008BN

Technical Diagram

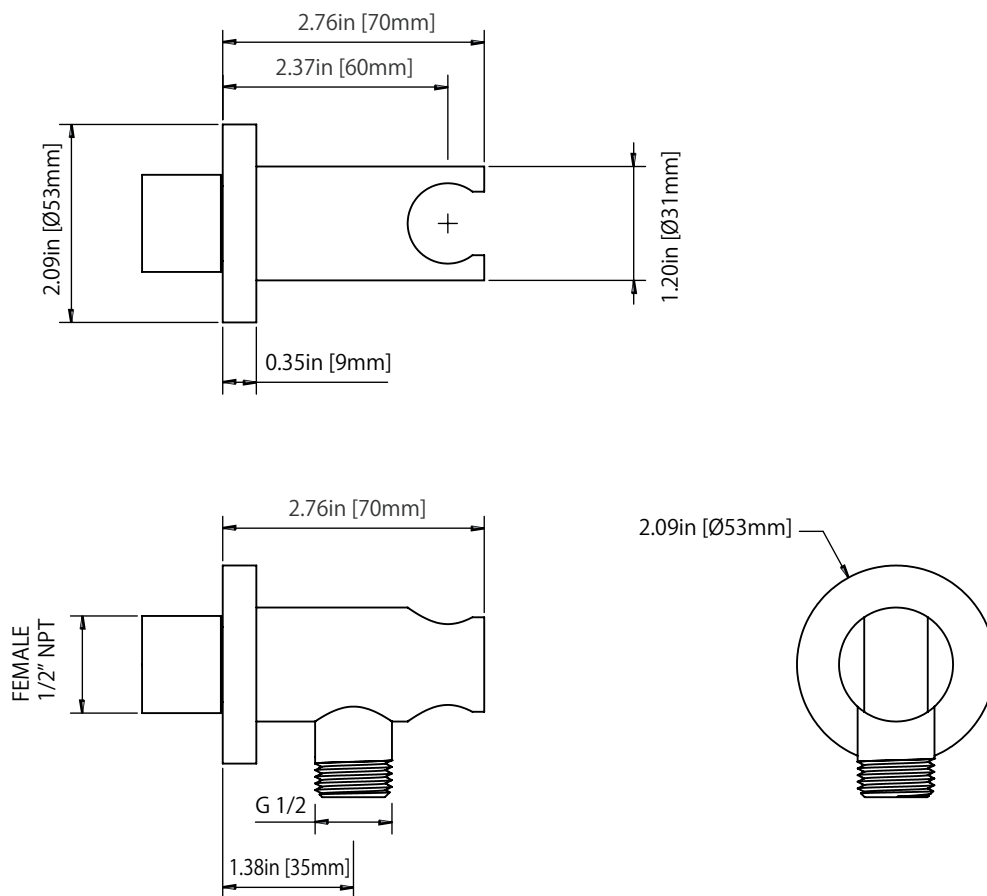

SP.150EM | Easy Maneuver Hose



SPECIFICATIONS:

- Stainless steel construction
- G-1/2" connection
- 1.5m length

Technical Diagram

