

# Product Parts Breakdown

▲ Specify Finish

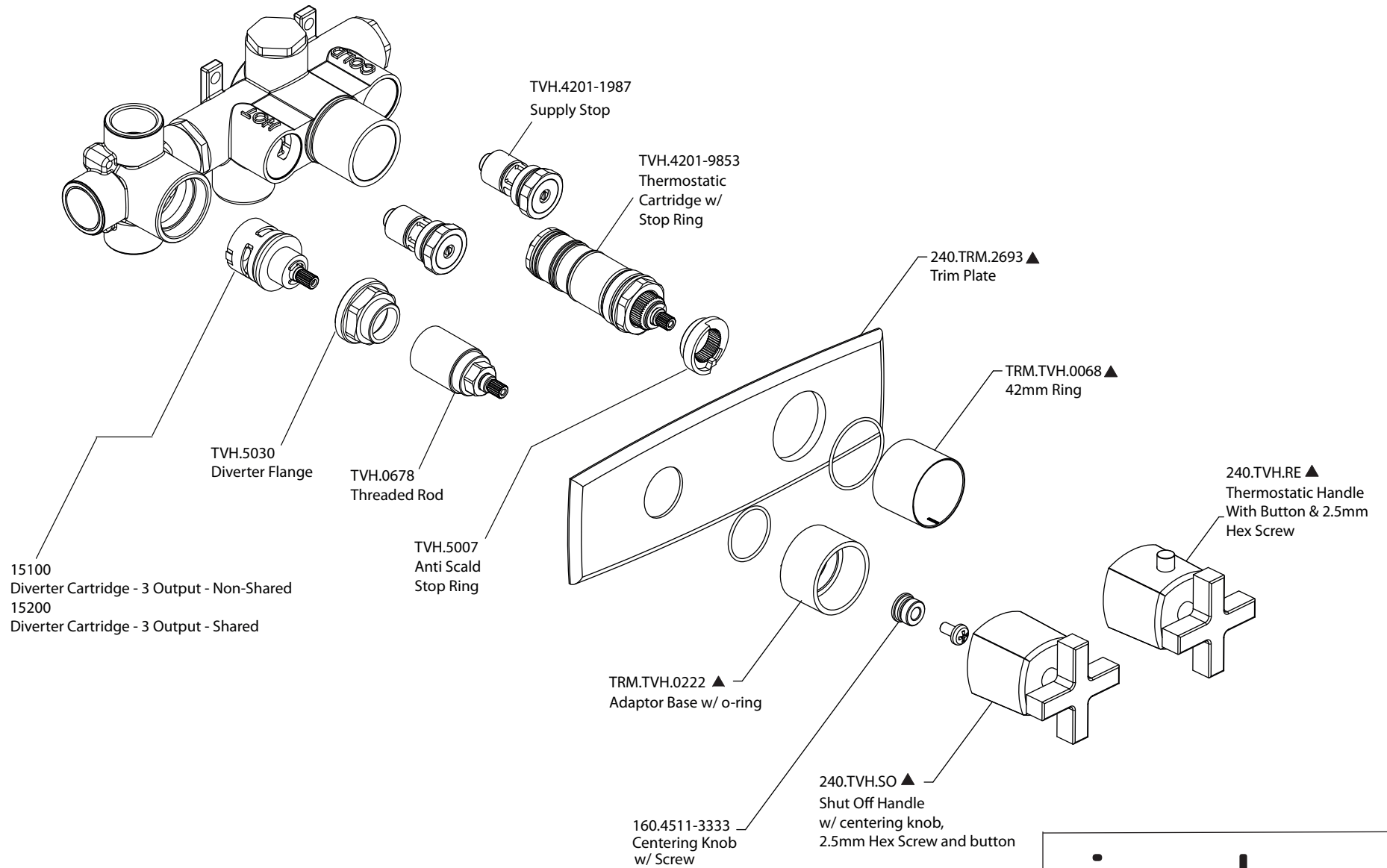

**isenberg**  
innovation+design

240.2705

Ver 2.53