

**240.4420 | 3/4" Thermostatic Valve With 2-Way Diverter & Integrated Volume Control & Trim**

**SPECIFICATIONS:**

- Turn bottom handle to control temperature.
- Turn top handle to divert water & control volume.
- Includes Thermostatic valve (TVH.4420F) w/ service stops
- Thermostatic Valve Flow Rate - 8.0 GPM @ 60 PSI
- Extension Available - TVH.4101E\*\*

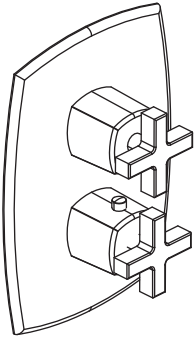

Trim  
[ 240.4000T\*\* ]

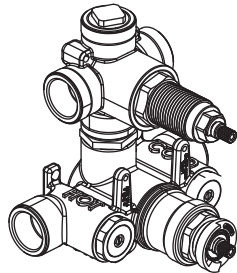

Valve  
[ TVH.4420F ]



A separate volume control is **not** needed to turn water supply off. Volume control functionality is integrated within this valve.

See Spec Sheet For TVH.4420F For Detailed Information On Valve.

**Technical Diagram**

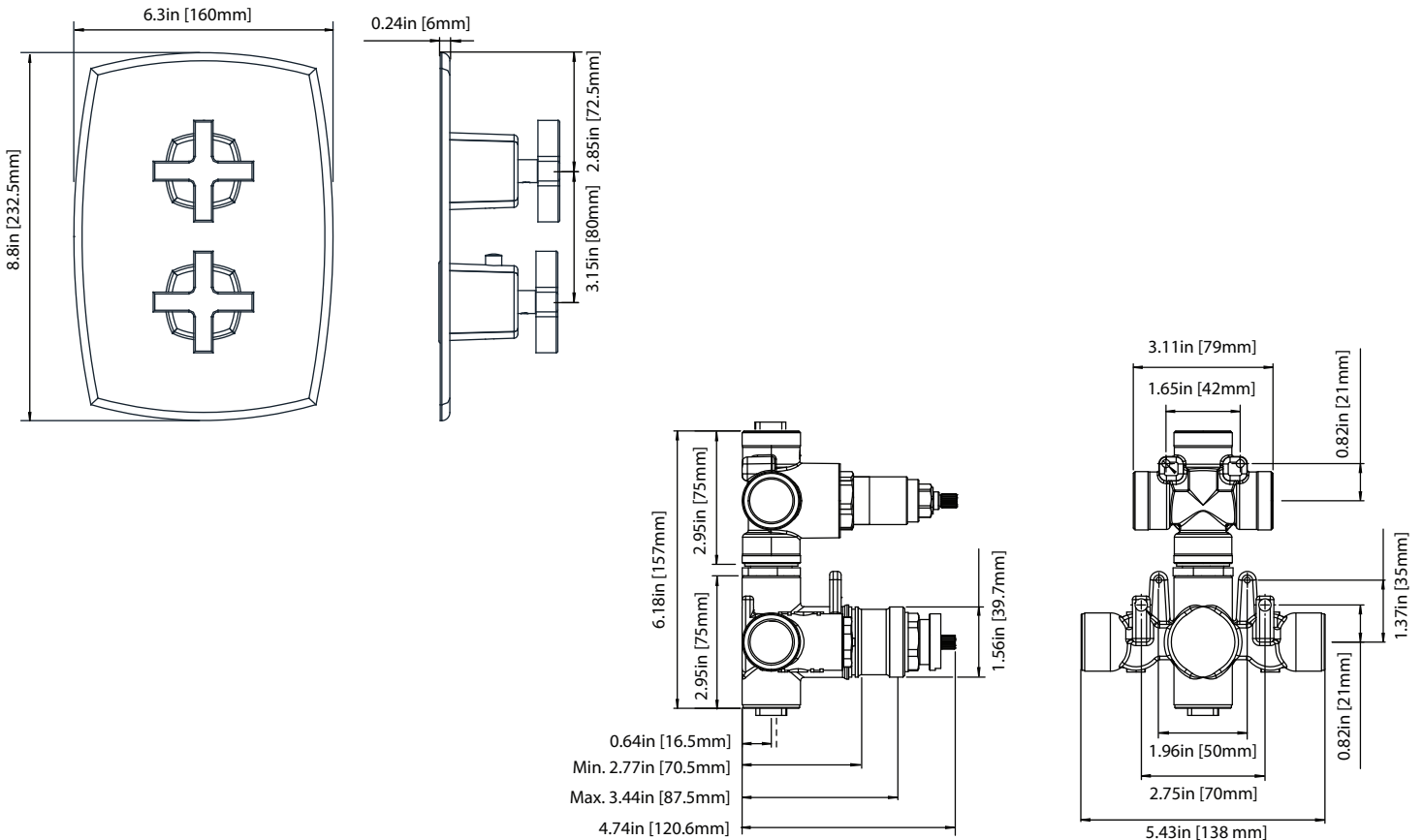

**TVH.4420F | 3/4" Thermostatic Valve With 2-Way Diverter & Integrated Volume Control** Page 2 of 2

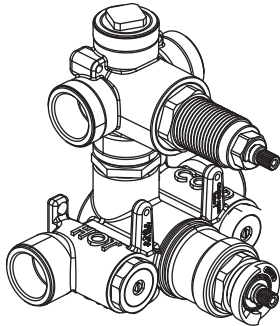

**SPECIFICATIONS:**

- Turn bottom knob to control temperature.
- Turn top knob to control water flow.
- Thermostatic Valve Flow Rate - 8.0 GPM @ 60 PSI
- Extension Available - TVH.4101E\*\*

**STANDARDS:**

- ASME A112.18.1 / CSA B125.1

**!** A separate volume control is **not** needed to turn water supply off. Volume control functionality is integrated within this valve.

**Technical Diagram**

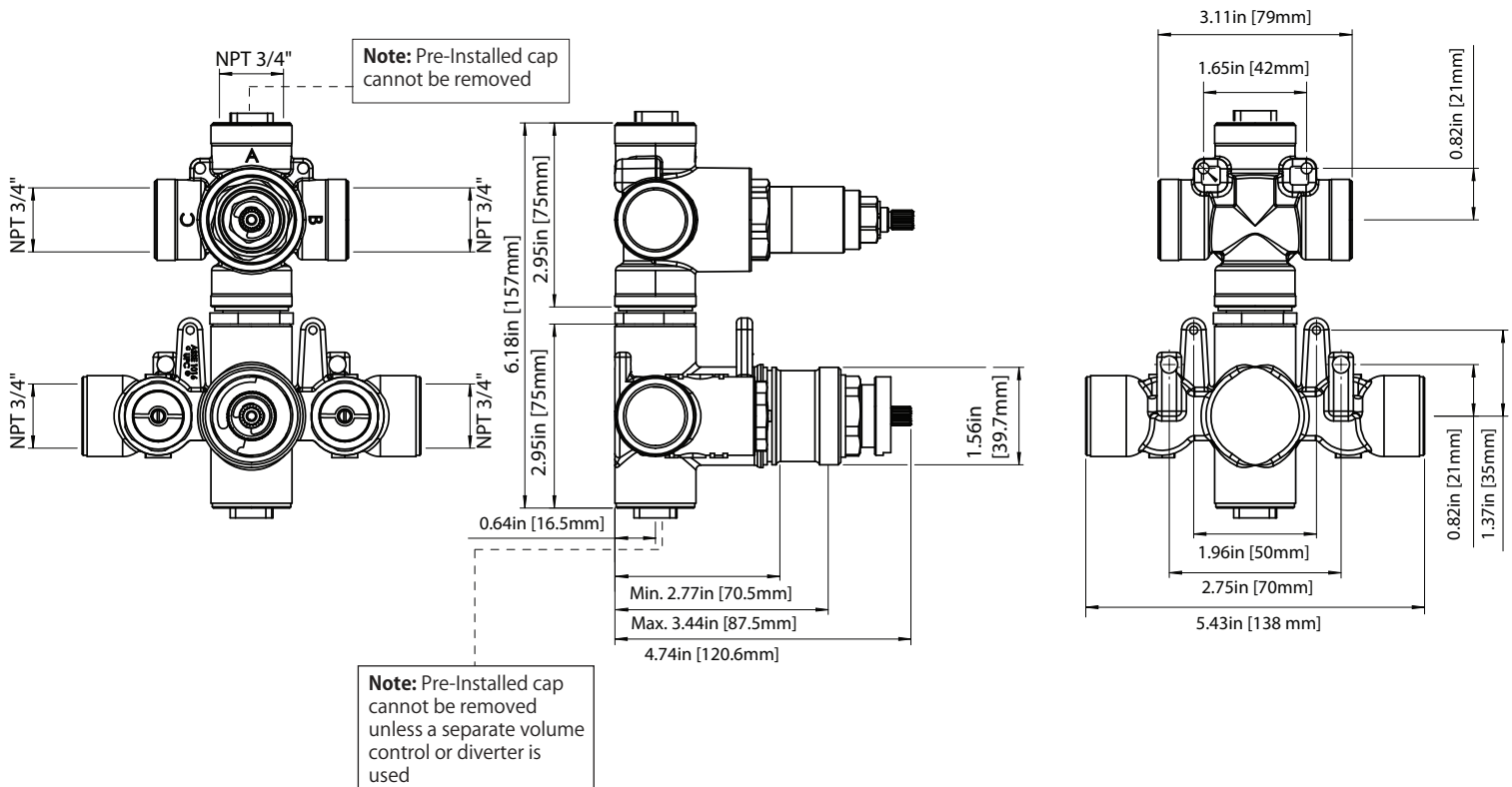

**TVH.4420F | 3/4" Thermostatic Valve With 2-Way Diverter & Integrated Volume Control** Page 2 of 2



**TWO OUTPUT - CAL-GREEN - NO SHARED PORT OPERATION**

Diverter Cartridge # - **15109** (Included)

Total 3 Positions as defined below, with **only** 1 port active at one time.

- Position 0 - Off - No Water Flow
- Position 1 - Output B Activated
- Position 2 - Output C Activated

**TWO OUTPUT - SHARED PORT OPERATION**

Diverter Cartridge # - **15103** (Not Included)

Total 4 Positions as defined below, with 2 ports active at one time.

- Position 0 - Off - No Water Flow
- Position 1 - Output B Activated
- Position 2 - Output B+C Activated
- Position 3 - Output C Activated

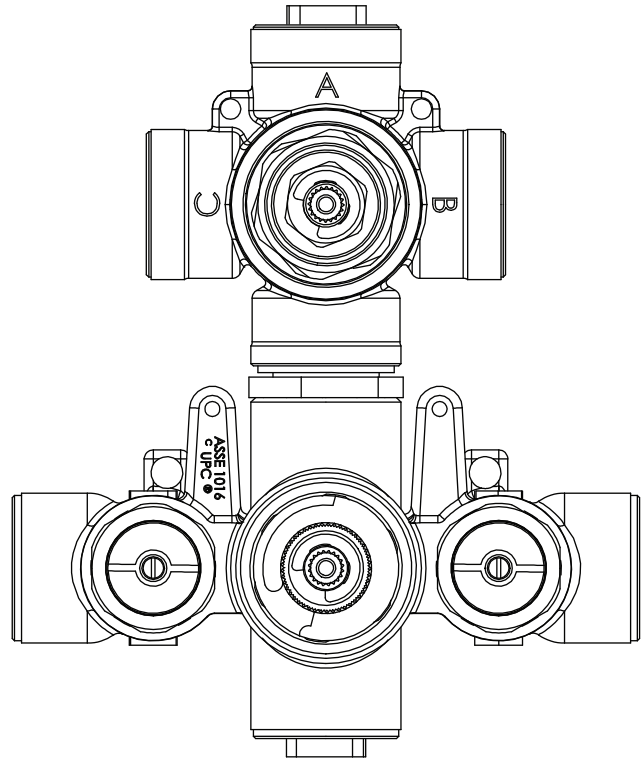

**Water Diversion Diagram**

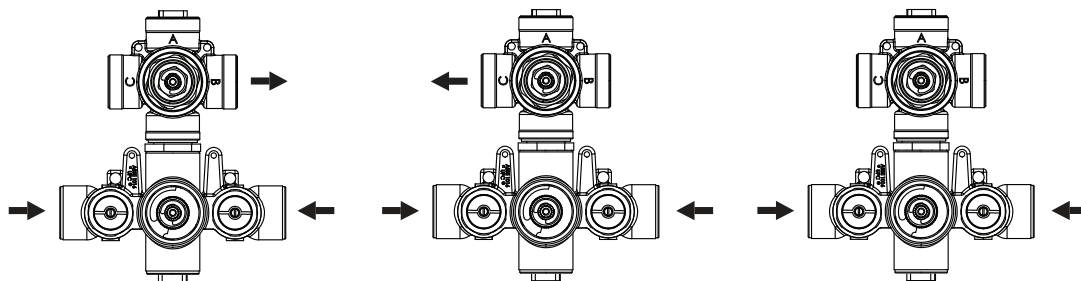

Diverter Position = 1

Diverter Position = 2

Diverter Position = off