

Installation Manual For 260.2420

5-Hole Deck Mount Roman Tub Filler With Hand Shower

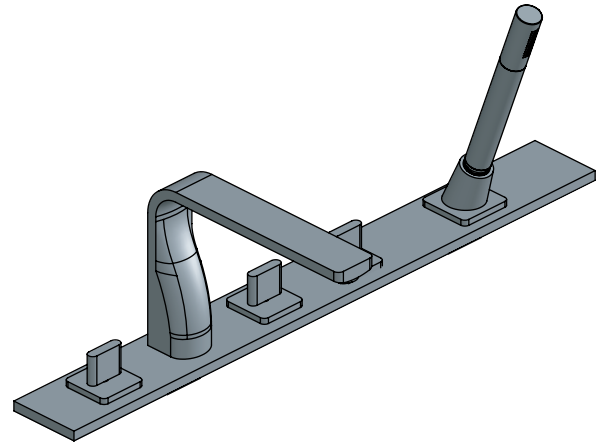

NOTICE TO HOMEOWNER

- We recommend that this product is installed by a qualified professional plumber.
- Please check this product immediately to ensure that it has not been damaged and is complete. Before installation, please make sure this product is the correct model and you have all the parts required for installation and use.
- Please flush the water system to ensure that no metal swarf, solder, and other impurities can enter the product.
- Turn off water supply before commencing work.
- Please read these instructions carefully and retain for future reference.



UNDER DECK ACCESS
PANEL IS REQUIRED FOR
MAINTENANCE AND
REPAIR OF DIVERTER
MECHANISM AND
CARTRIDGES

BEFORE YOU BEGIN

- You must observe all local plumbing laws and codes.
- Do not instal valve if it does not meet local plumbing codes.
- Shut off the main water supply.

Installation Manual For 260.2420

5-Hole Deck Mount Roman Tub filler With Hand Shower

TABLE OF CONTENTS

OPERATING SPECIFICATIONS	3
INSTALLING THE HOT & COLD HANDLES	4
INSTALLING THE HANDLE & DIVERTER	6
INSTALLING THE TUB SPOUT	8
INSTALLING THE HAND SHOWER	9
INSTALLING THE HOSES	10

OPERATING SPECIFICATIONS

WATER TEMPERATURE



This product is to be used with water at a temperature range of 40°F - 120°F ONLY!

WATER PRESSURE



This product is to be used with a water pressure range of 15 PSI to 80 PSI ONLY

If water pressure is greater than 80 PSI, install a pressure reducer valve (PRV)

This valve meets or exceeds ANSI A112.18.1 and ASSE 1016

INSTALLING THE HOT & COLD HANDLES

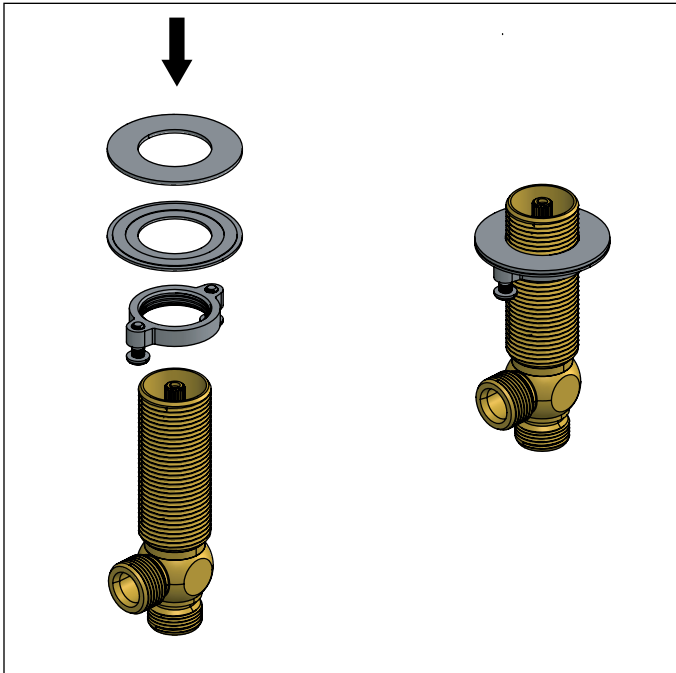

Install nut and washer onto valve. Then insert handle extension and tighten screw

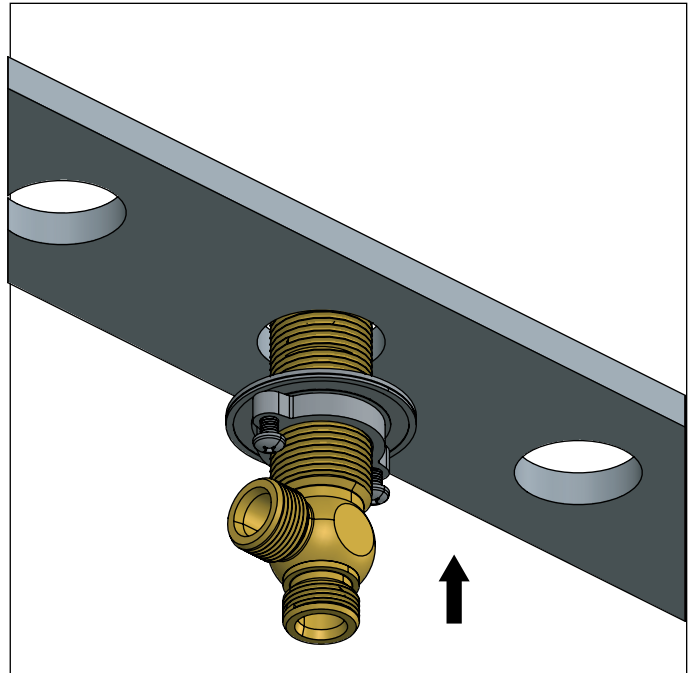

Install valve into 1-3/8" hole from below the deck

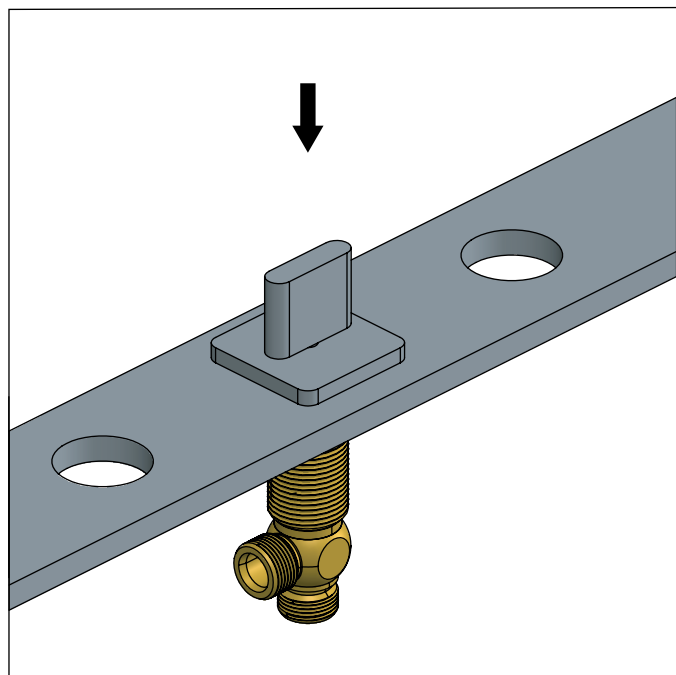

Install body from top of deck and twist to tighten

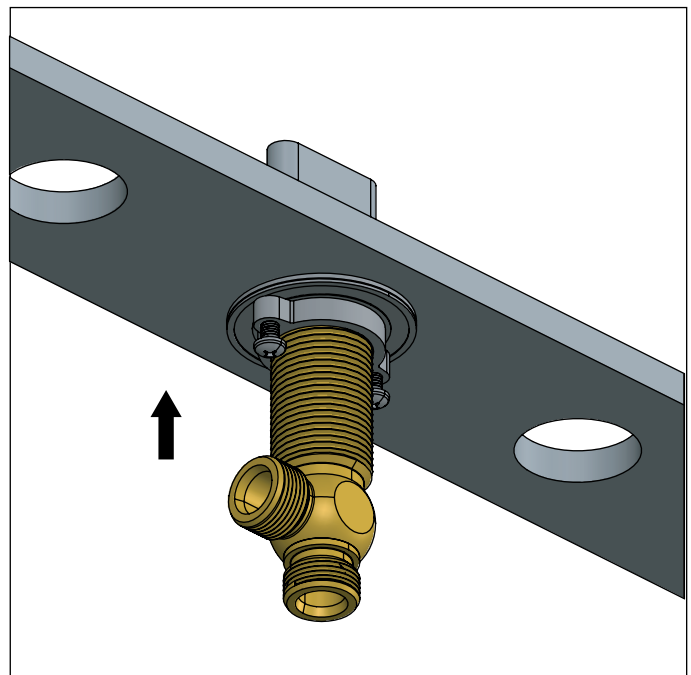

Tighten nut and washer from bottom of deck

INSTALLING THE HOT & COLD HANDLES

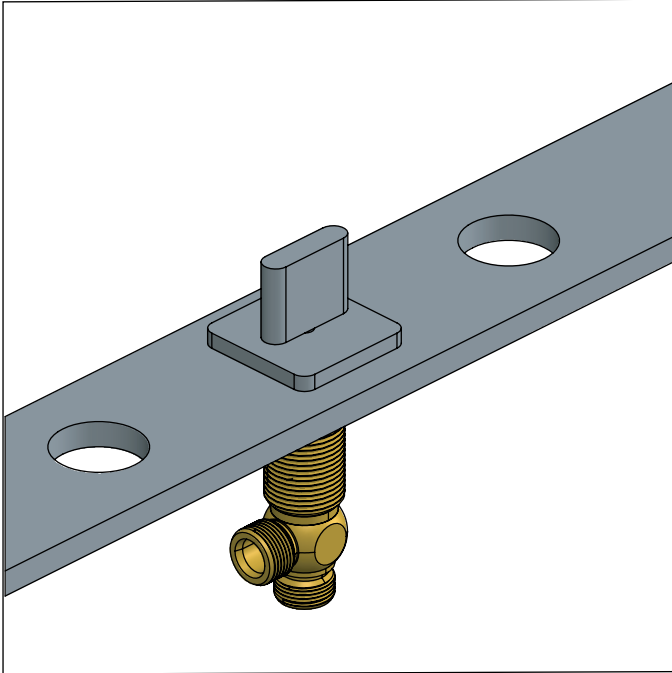

Twist to verify smooth operation

INSTALLING THE HANDLES & DIVERTER

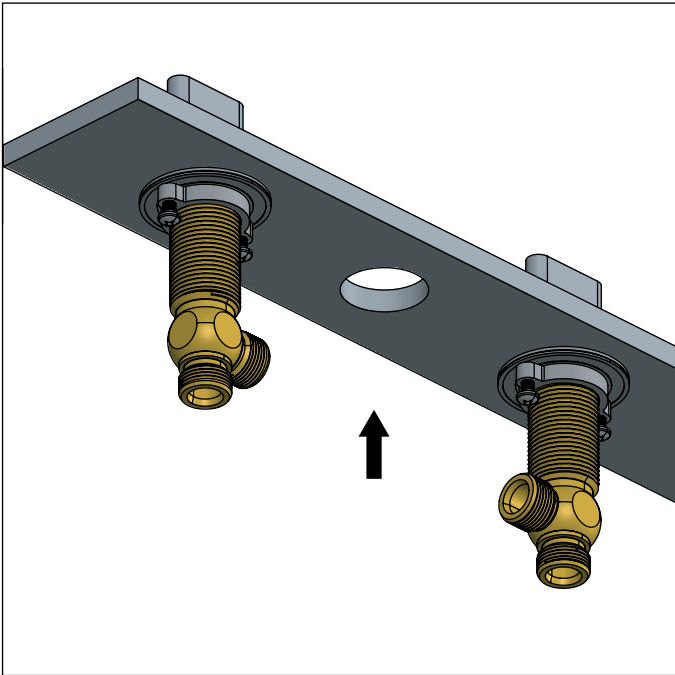

Tighten nut and washer from bottom of deck

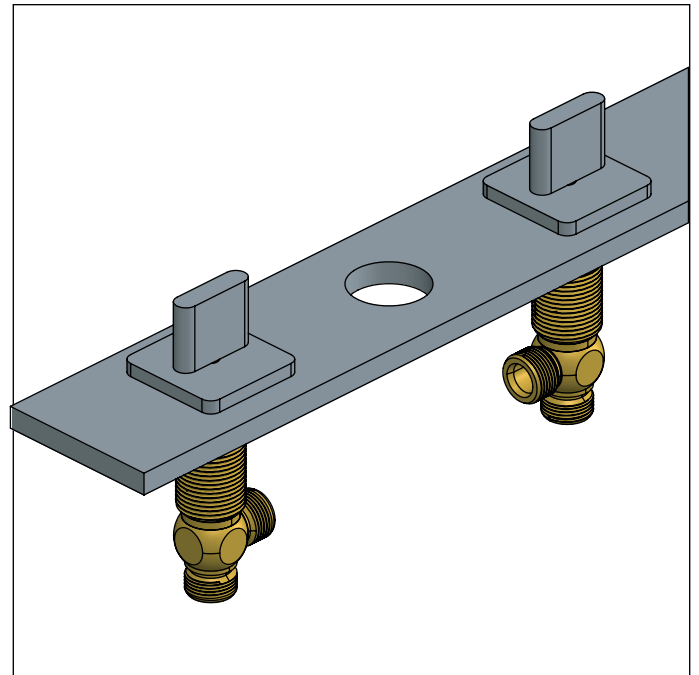

Twist to verify smooth operation

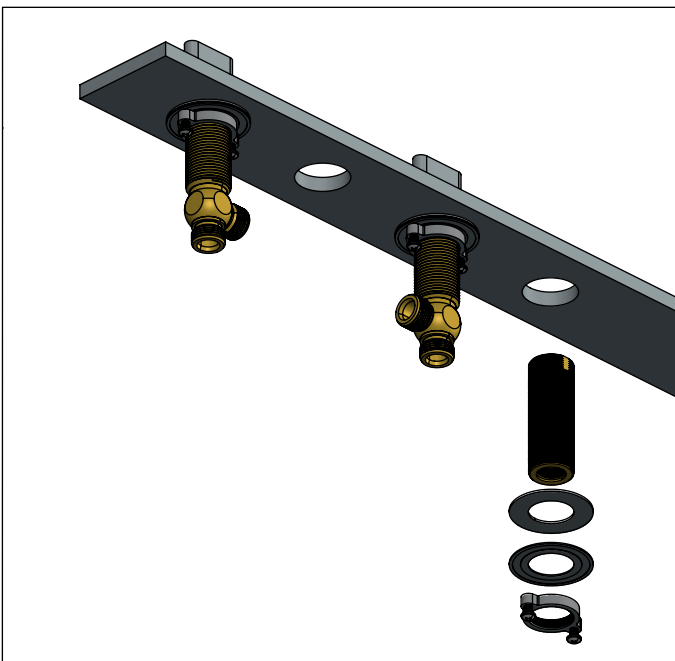

Insert diverter nut and attachment from bottom

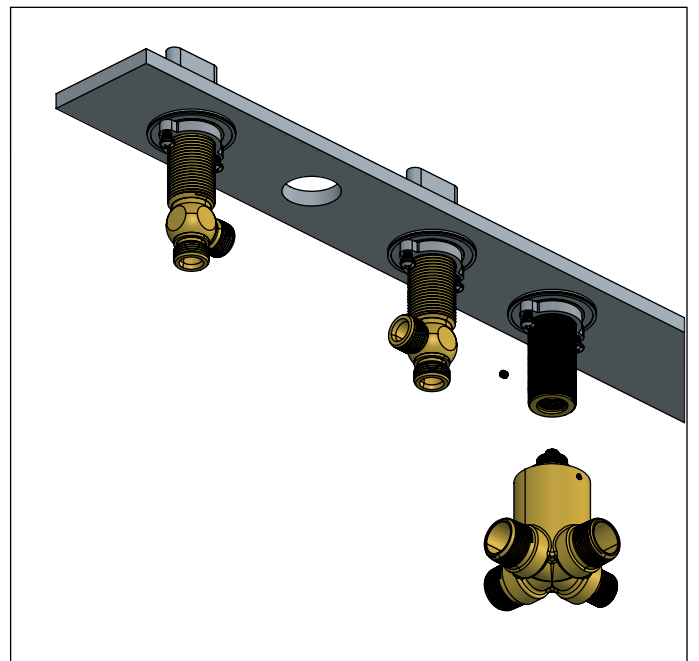

Install the diverter from bottom

INSTALLING THE HANDLES & DIVERTER

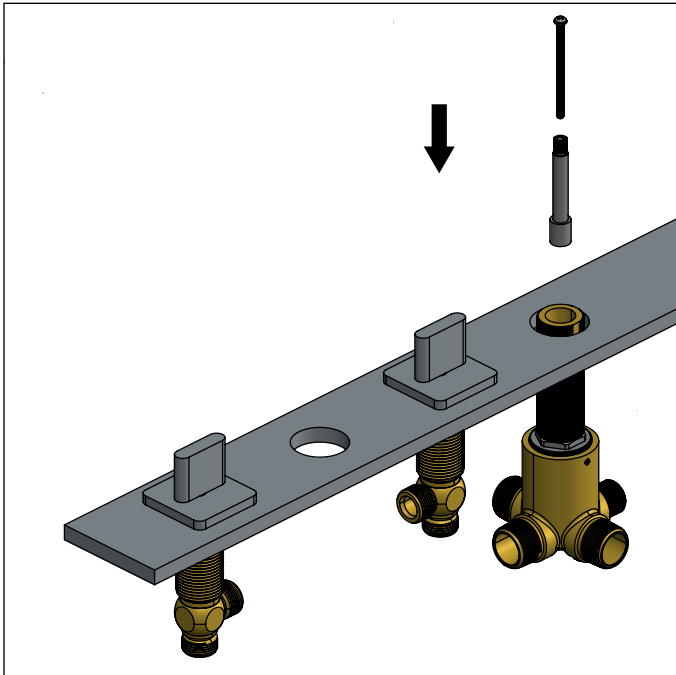

Install the screw & extension

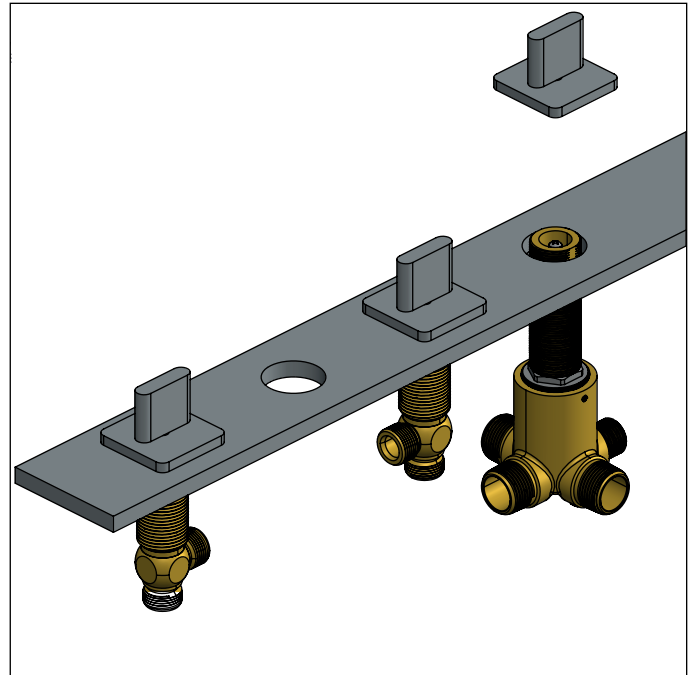

Install handle from top of deck and tighten set-screw

INSTALLING THE TUB SPOUT

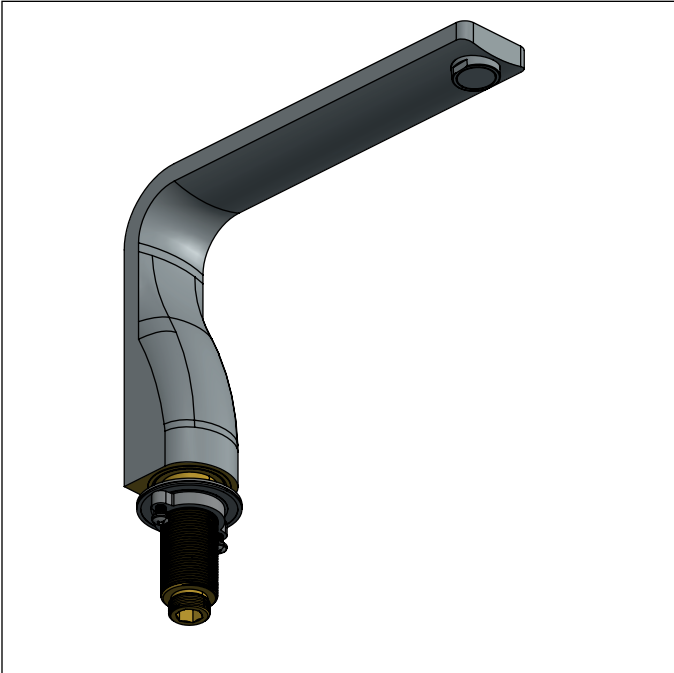

The Spout is seen above



Remove components from cartridge

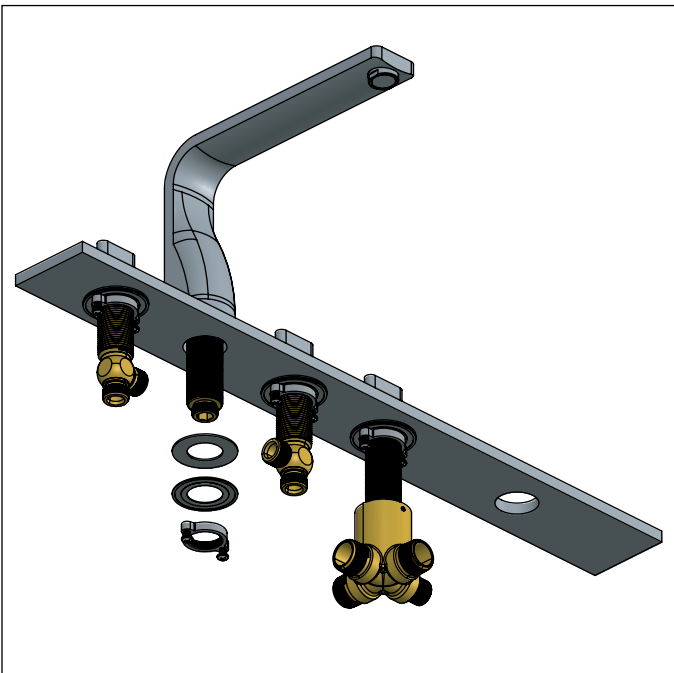

Insert spout into deck hole, then insert washers and tighten retaining nut

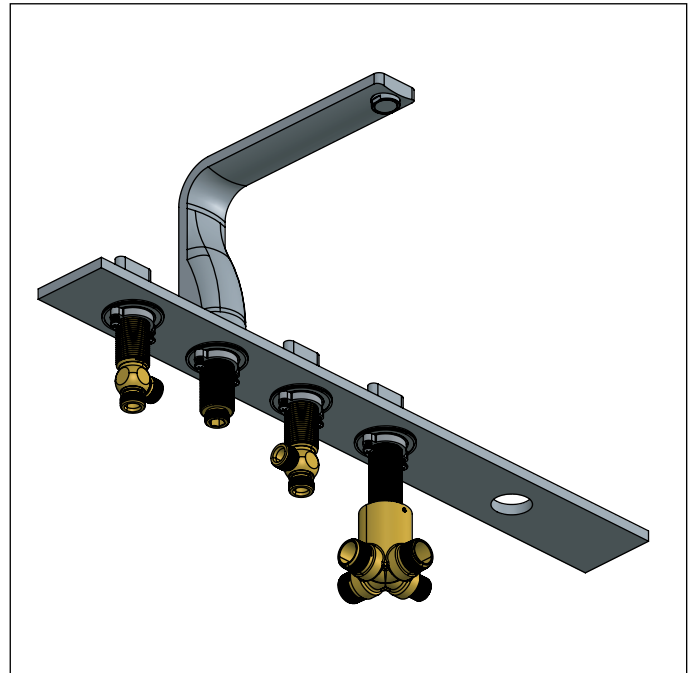

INSTALLING THE HAND SHOWER

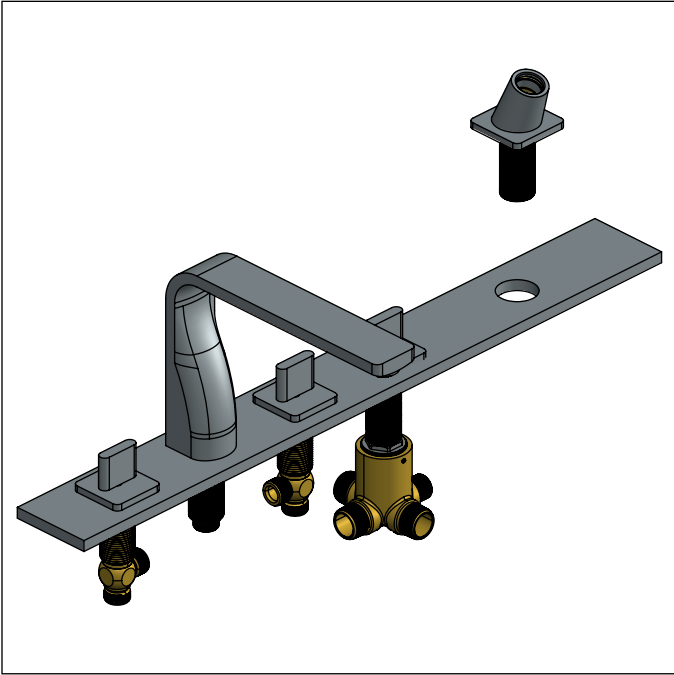

Drop hand shower deck holder into deck hole

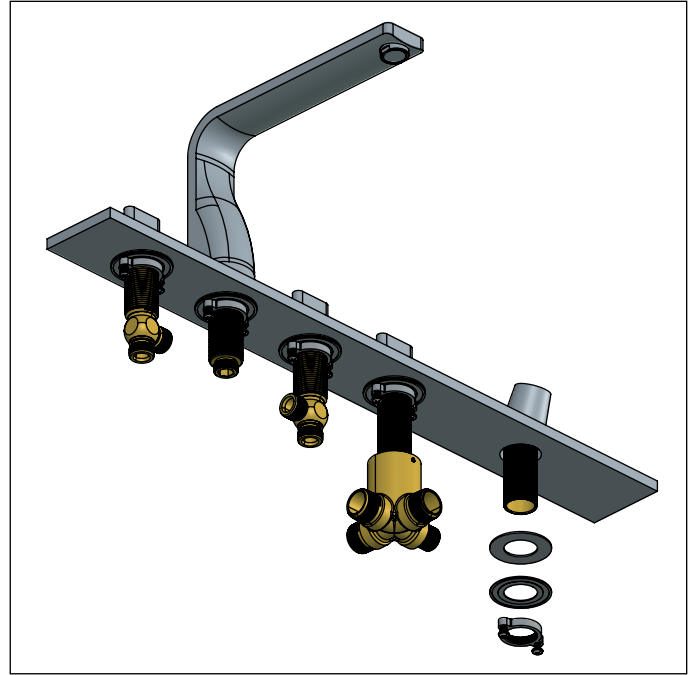

Insert & Tighten nut and washers from bottom of deck

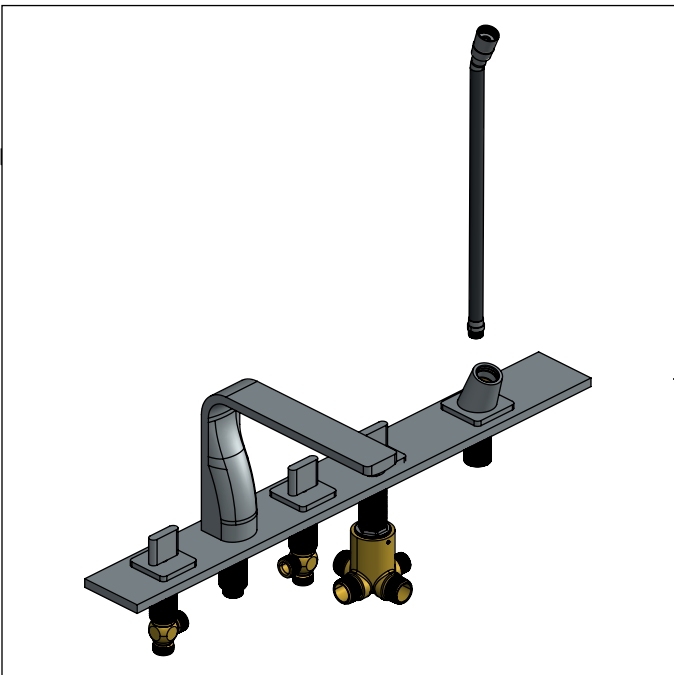

Drop hose down through deck hole

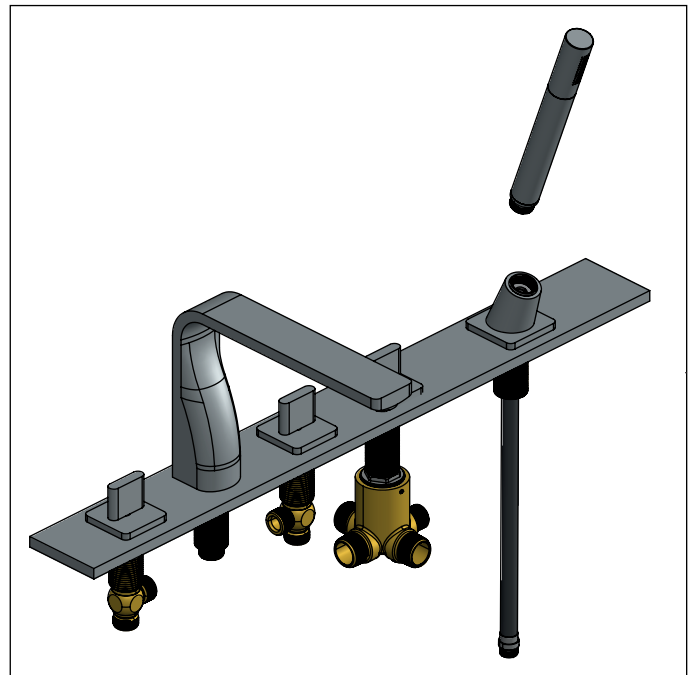

Attach hose to hand shower

INSTALLING THE HOSES

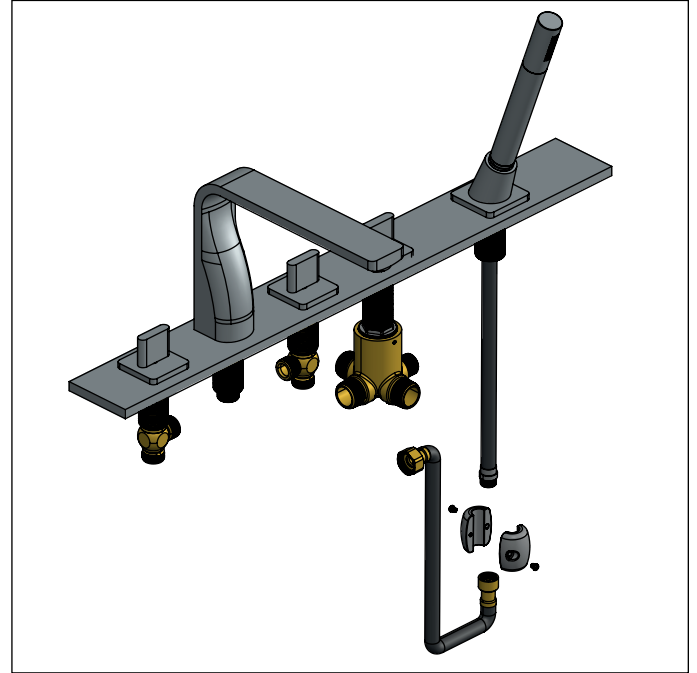
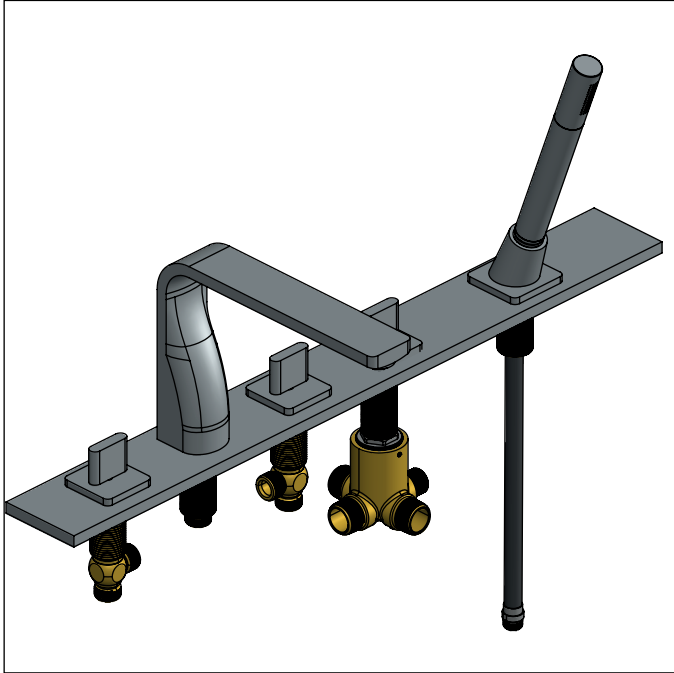

Connect 2nd piece of hand shower hose

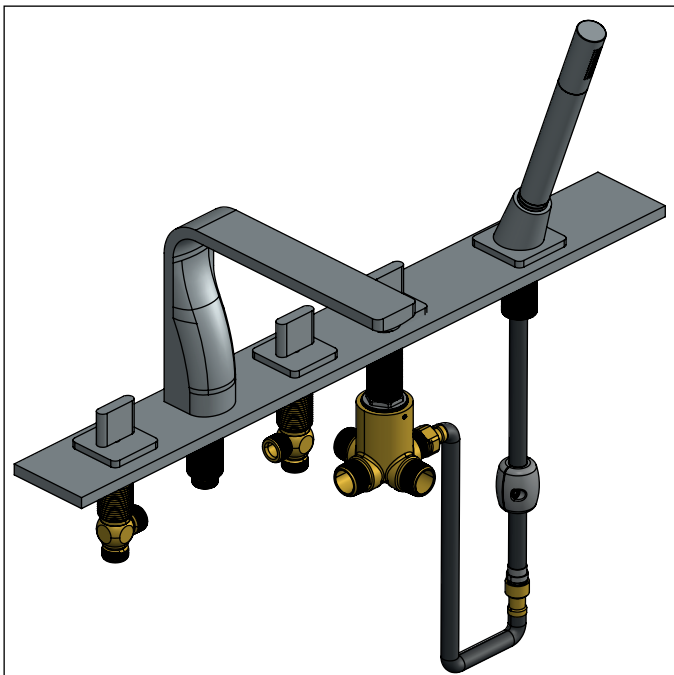

Connect hand shower hose to valve

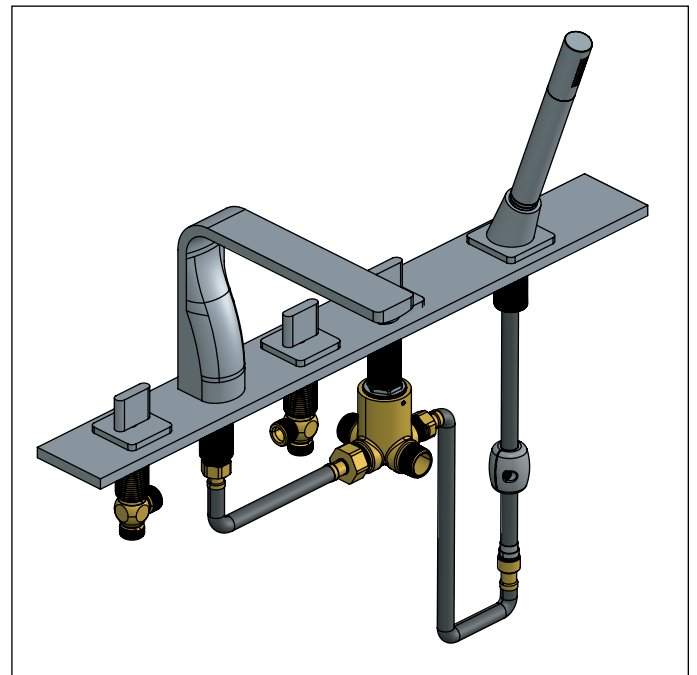

Connect spout to valve

INSTALLING THE HOSES

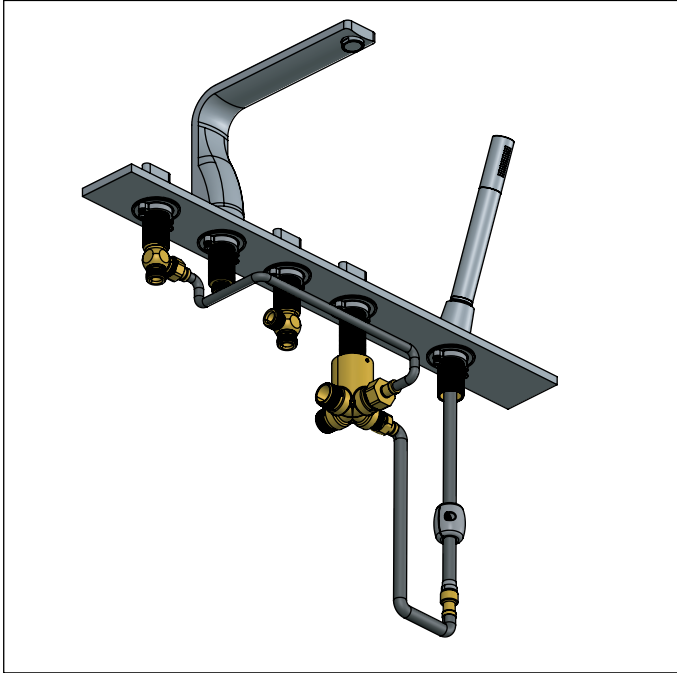

Connect hot side to diverter valve

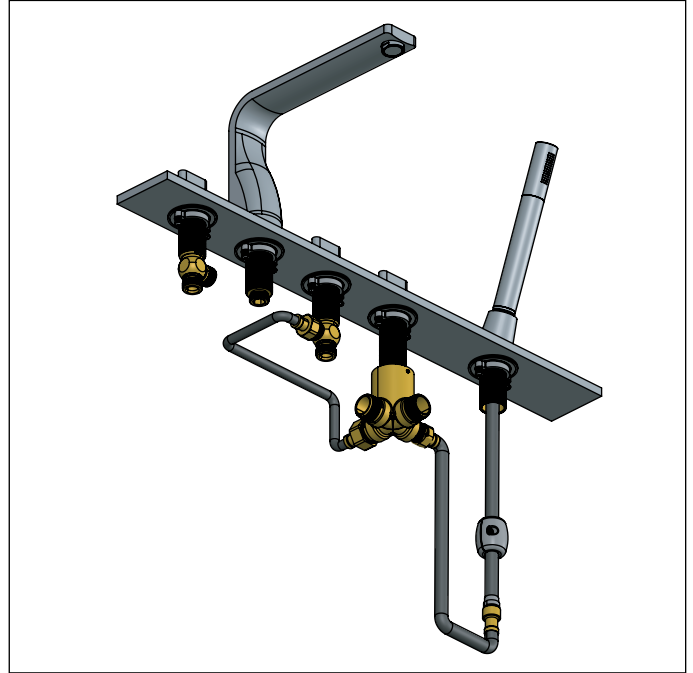

Connect cold side to diverter valve



Connect Hot & Cold-Side Connection

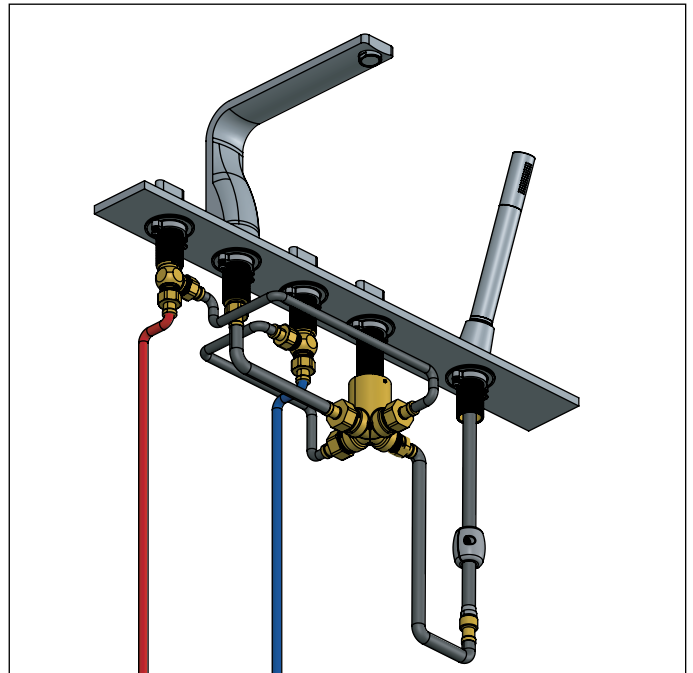

All hoses connected seen here