

Product Parts Breakdown

▲ Specify Finish

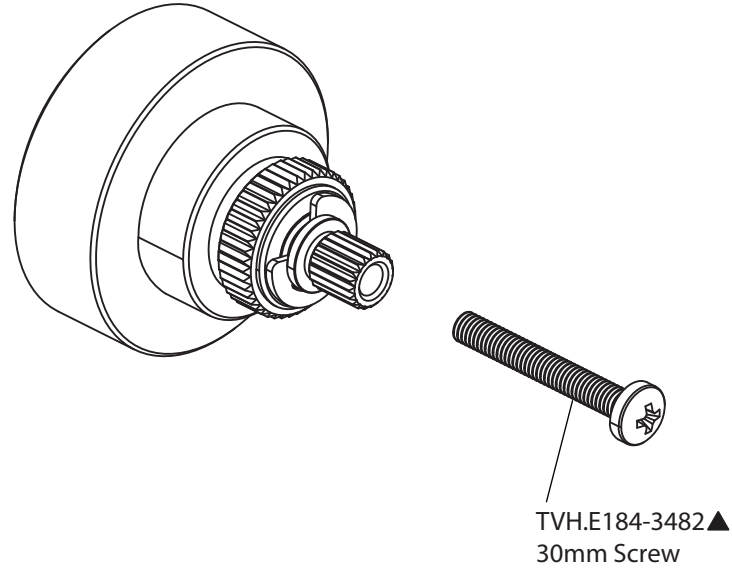

isenberg
innovation+design

TVH.E184

Ver 2.53