

Product Parts Breakdown

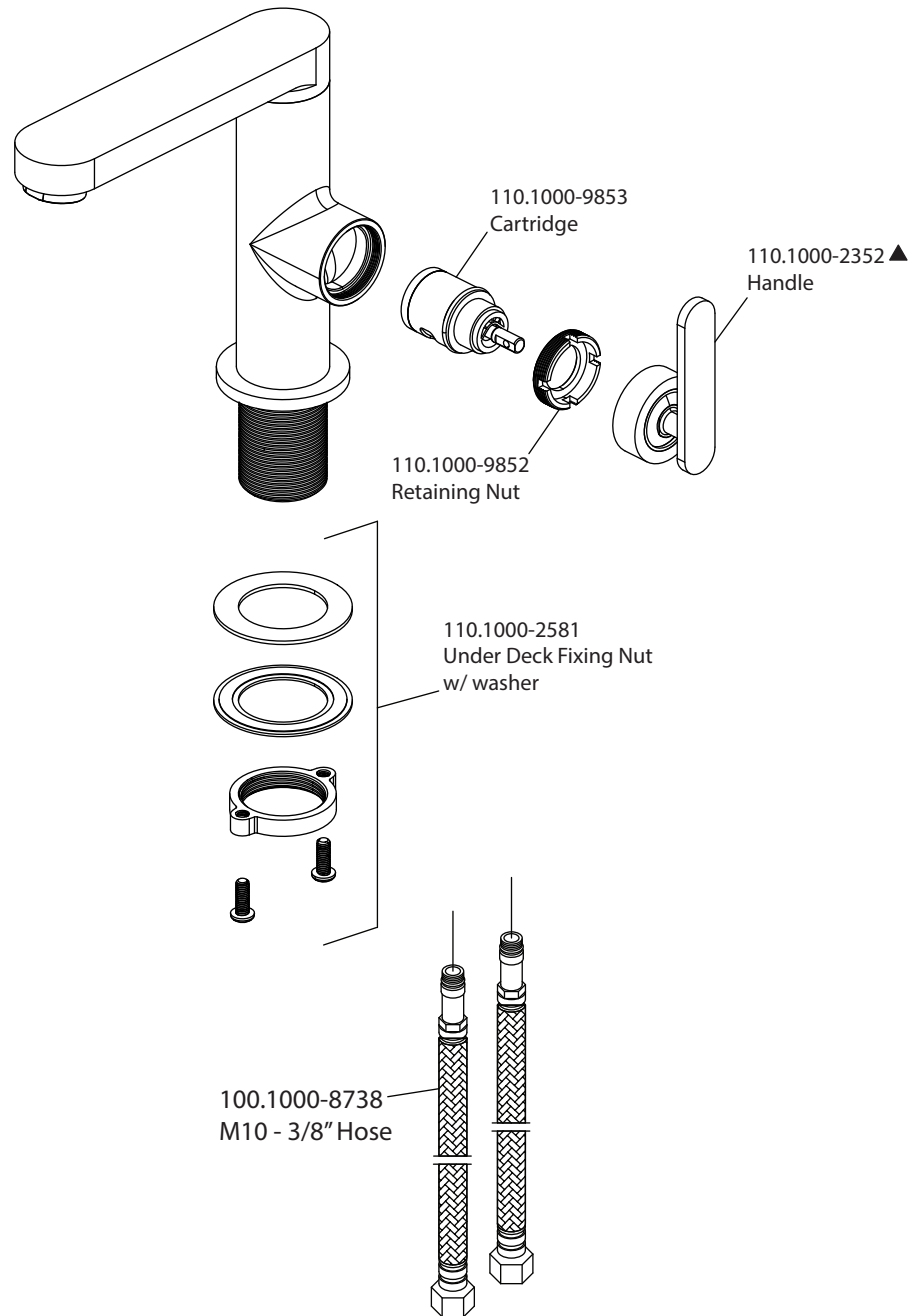

isenberg
innovation+design

110.1000

Ver 2.53