

# Product Parts Breakdown Using TVH.4301F Valve

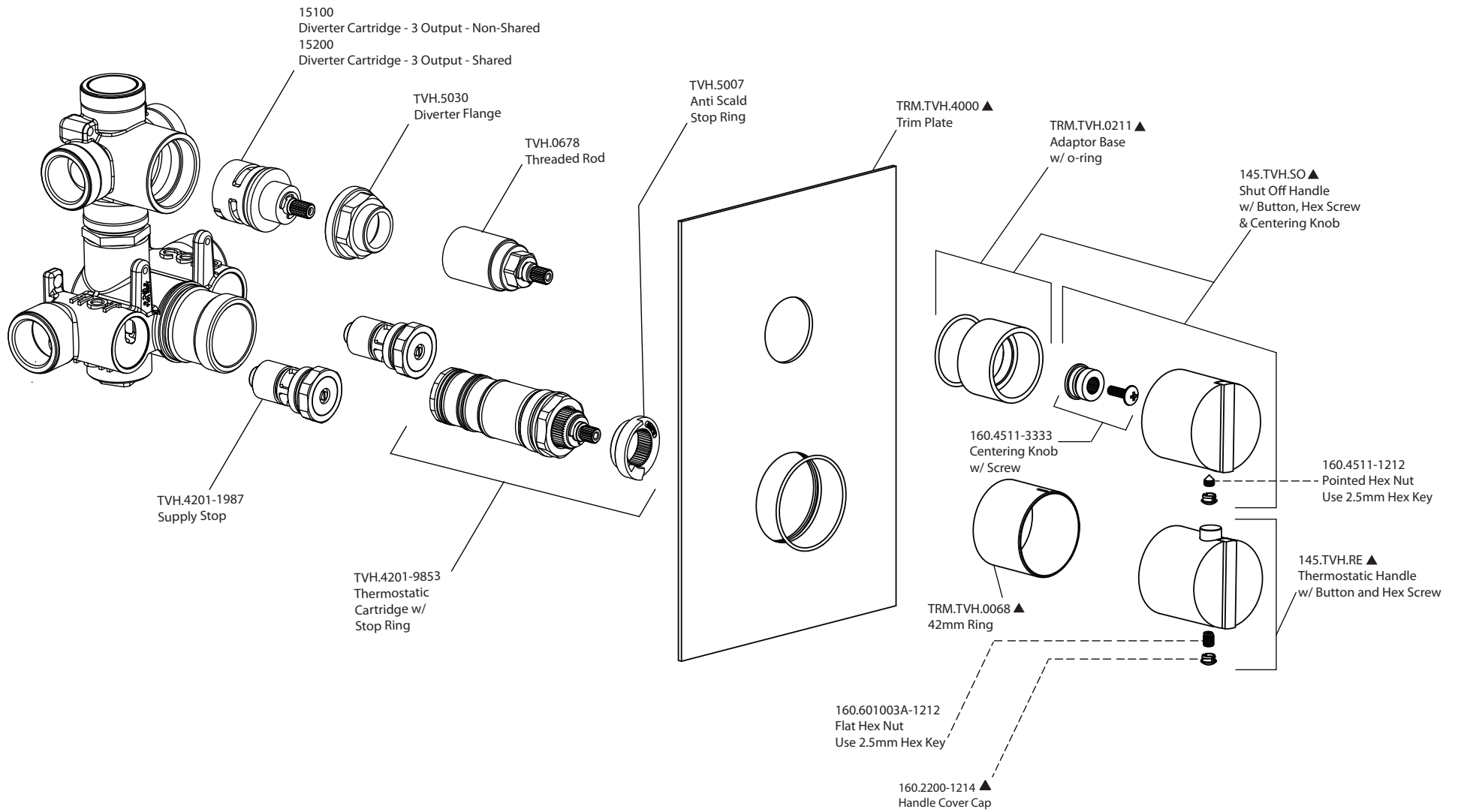

**isenberg**  
innovation+design

145.4301

# Product Parts Breakdown Using TVH.4301 Valve

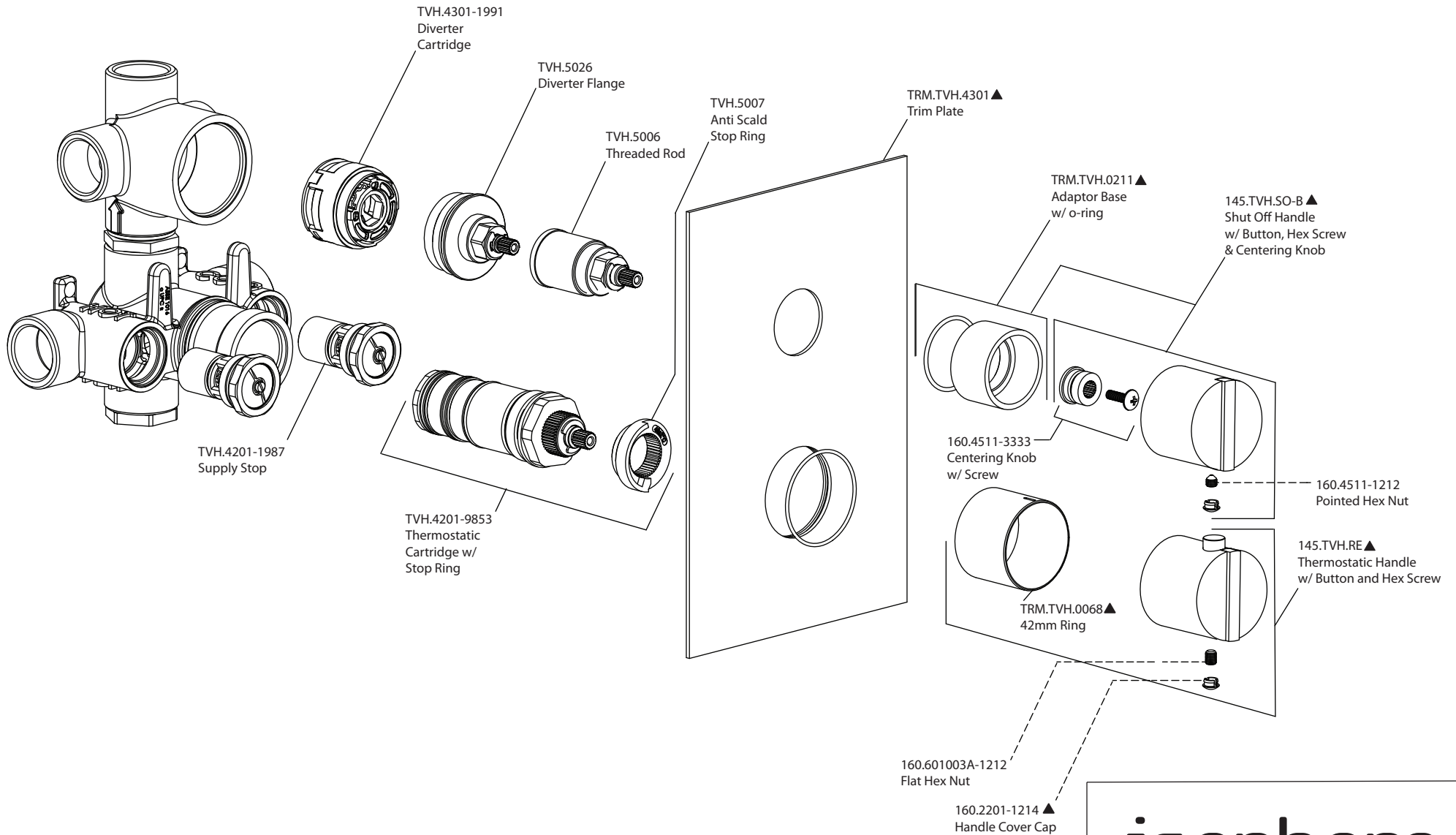

**isenberg**  
innovation+design

145.4301