

Product Parts Breakdown

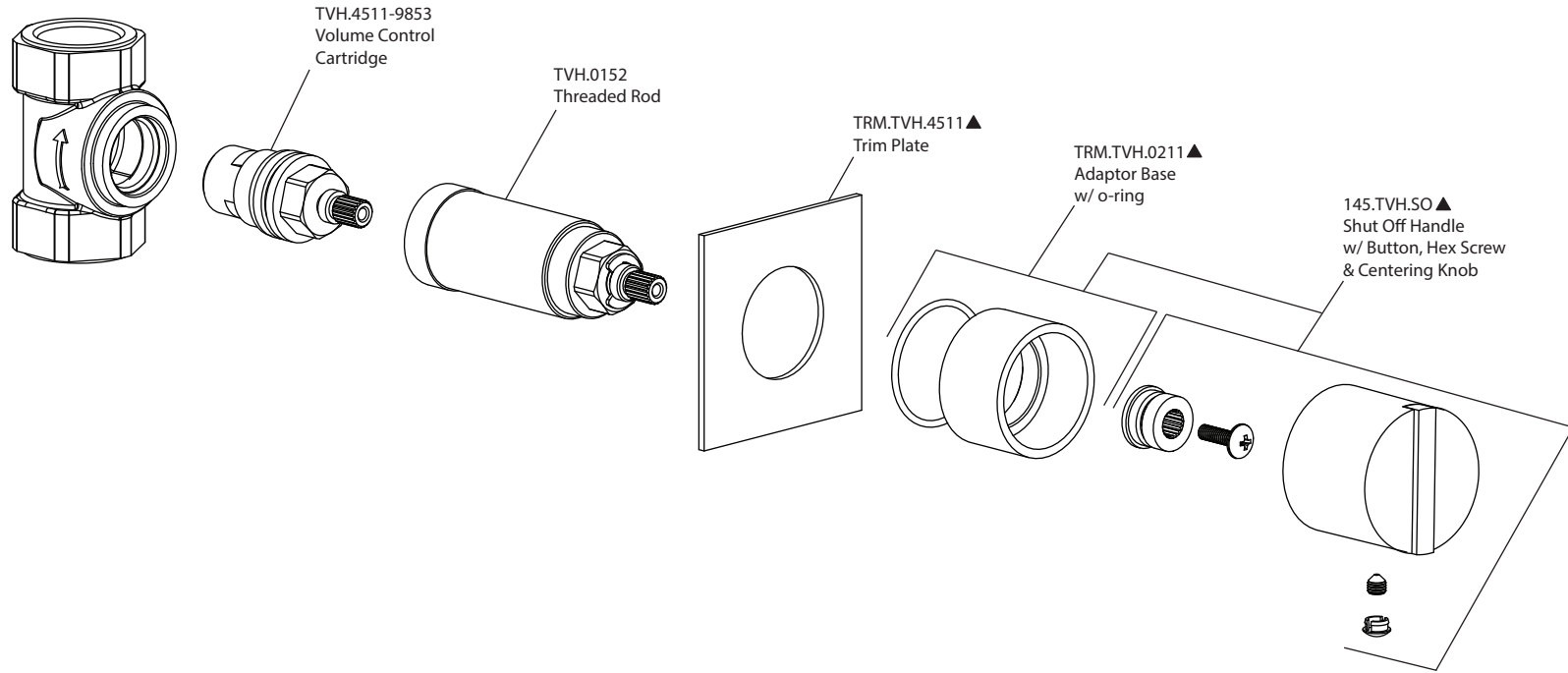

isenberg
innovation+design

145.4511