

Product Parts Breakdown

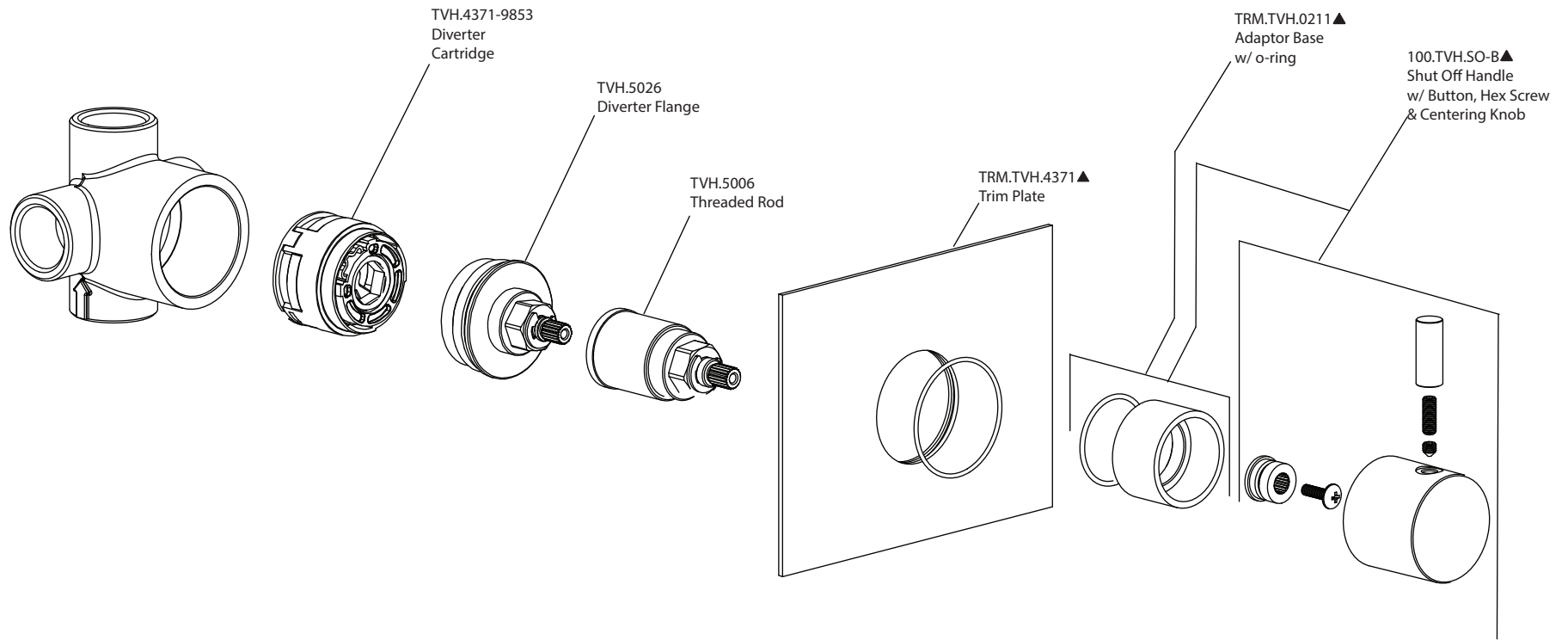

isenberg
innovation+design

100.4371