

Product Parts Breakdown Using TVH.4420F Valve

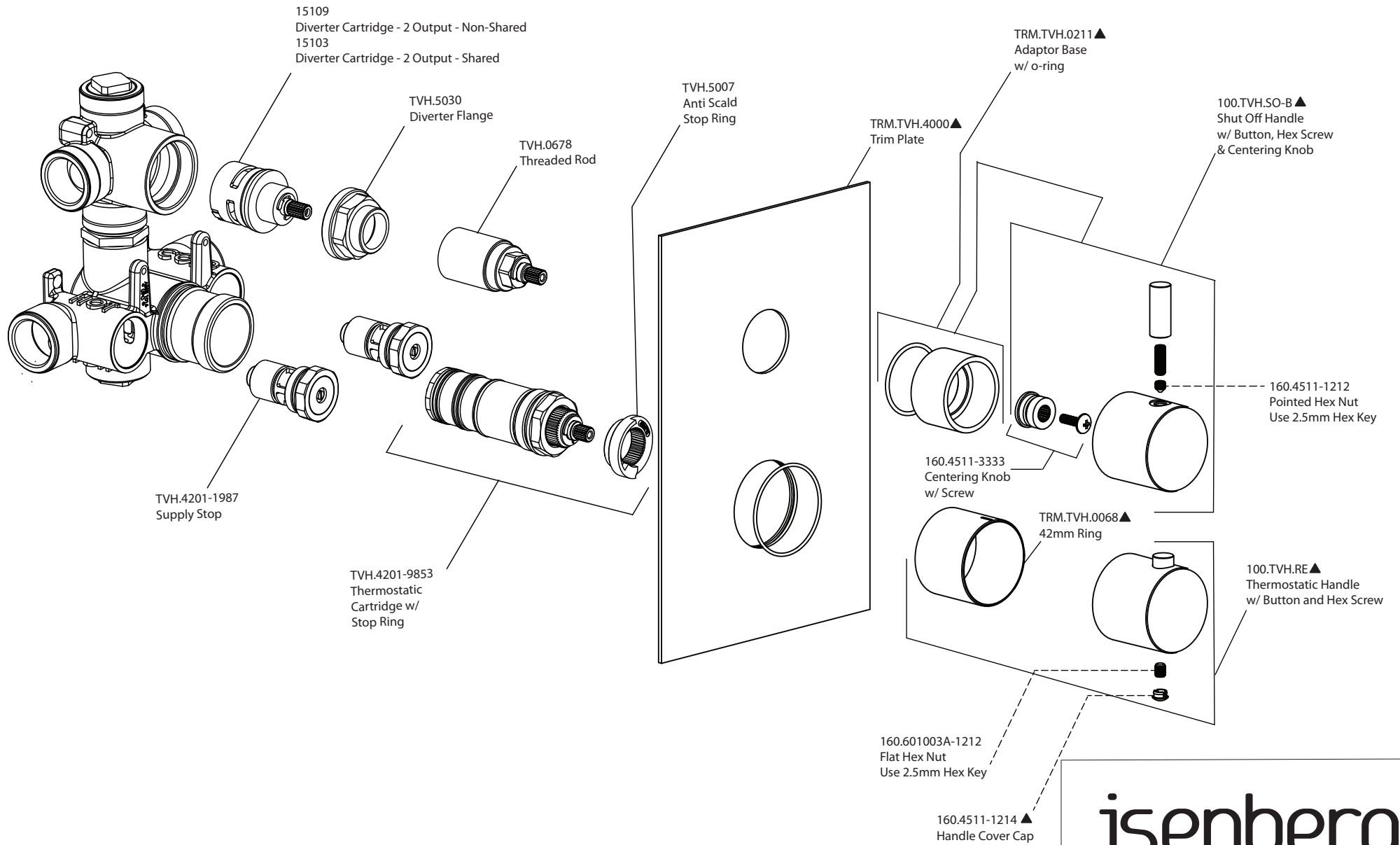

isenberg
innovation+design

100.4420

Product Parts Breakdown Using TVH.4420 Valve

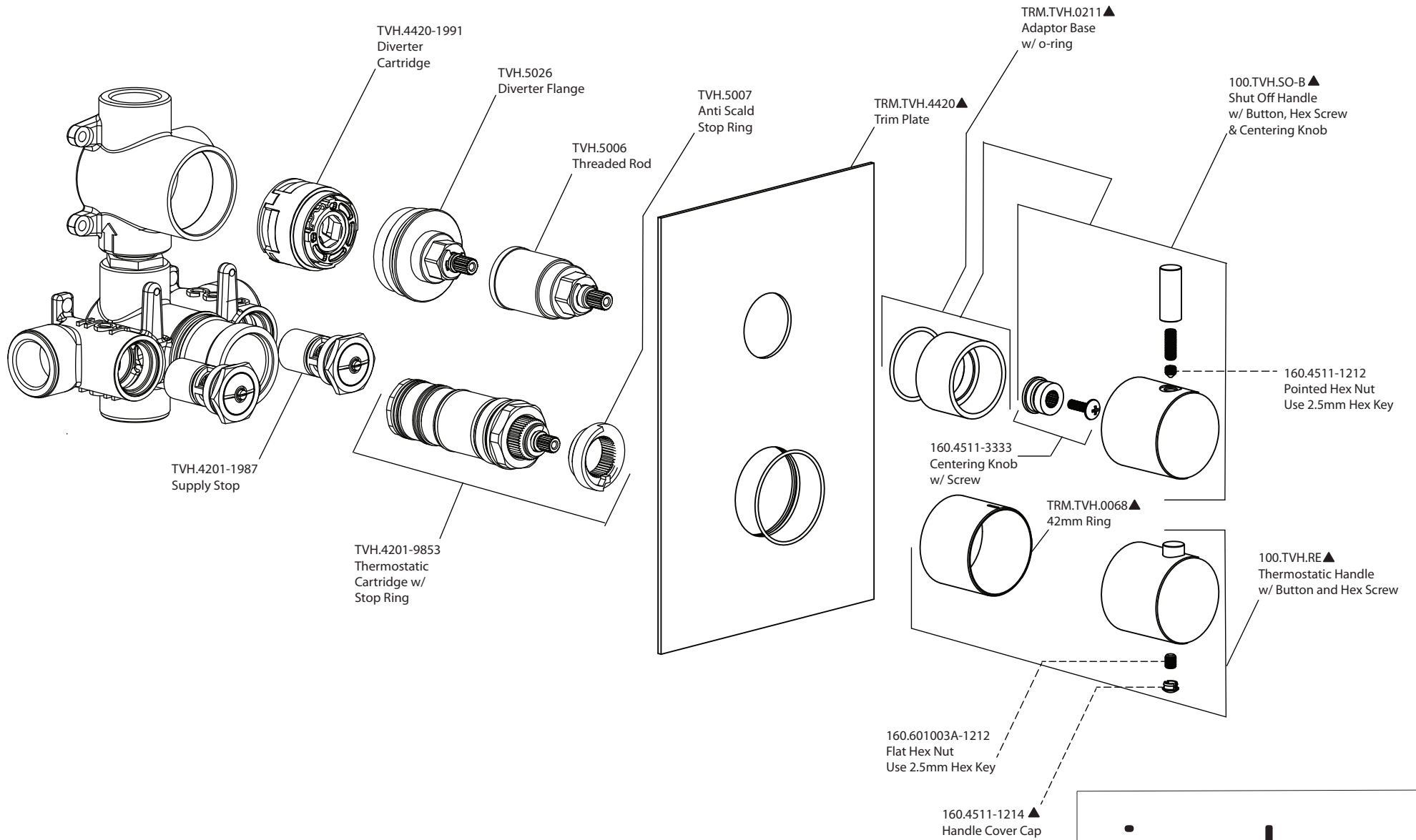

isenberg
innovation+design

100.4420