

Product Parts Breakdown

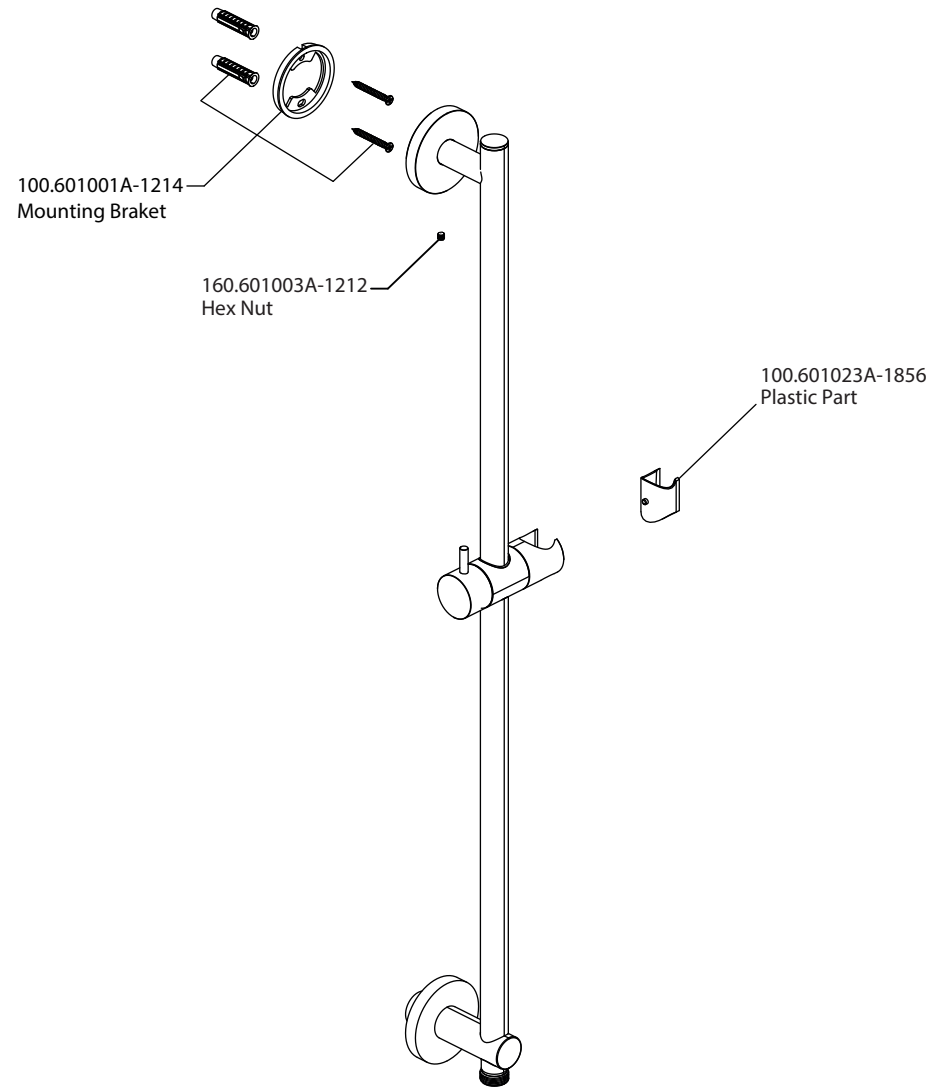

isenberg
innovation+design

100.601023A

Ver 2.54