

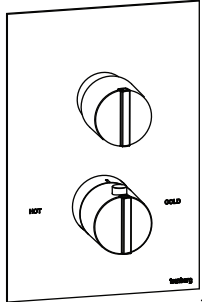

145.4301 | 3/4" Thermostatic Valve With 3-Way Diverter & Integrated Volume Control & Trim

SPECIFICATIONS:

- Turn bottom handle to control temperature.
- Turn top handle to divert water & control volume.
- Includes Thermostatic valve (TVH.4301F) w/ service stops
- Thermostatic Valve Flow Rate - 8.0 GPM @ 60 PSI
- Extension Available - TVH.4101E**



Trim
[145.4000T**]

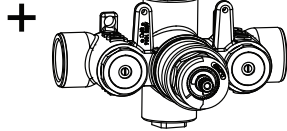

Valve
[TVH.4301F]

CALGreen Compliant



Belgian Mirror Finish



Legislation Compliance



ZeroDrip Technology



!
A separate volume control is **not** needed to turn water supply off. Volume control functionality is integrated within this valve.

See Spec Sheet For TVH.4301F For Detailed Information On Valve.

Technical Diagram

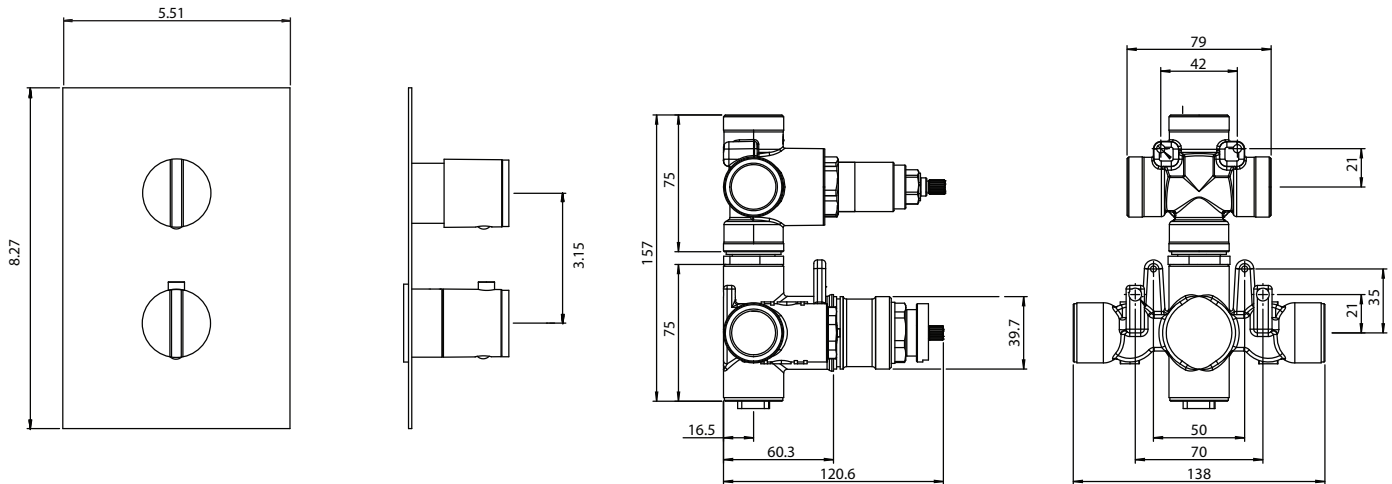

Water Diversion Diagram

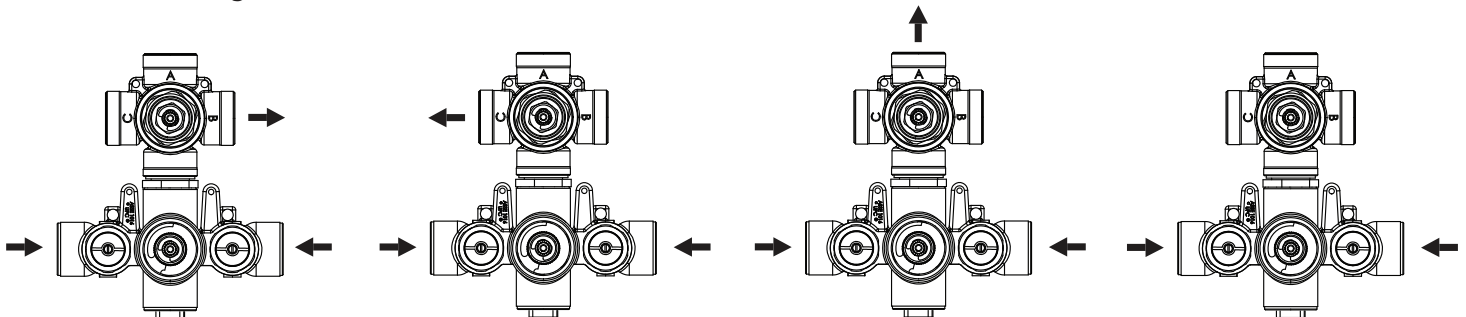

Diverter Position = 1

Diverter Position = 2

Diverter Position = 3

Diverter Position = off



TVH.4301F | 3/4" Thermostatic Valve With 3-Way Diverter & Integrated Volume Control Page 1 of 2

SPECIFICATIONS:

- Turn bottom knob to control temperature.
- Turn top knob to control water flow.
- Thermostatic Valve Flow Rate - 8.0 GPM @ 60 PSI
- Extension Available - TVH.4101E**

STANDARDS:

- ASME A112.18.1 / CSA B125.1

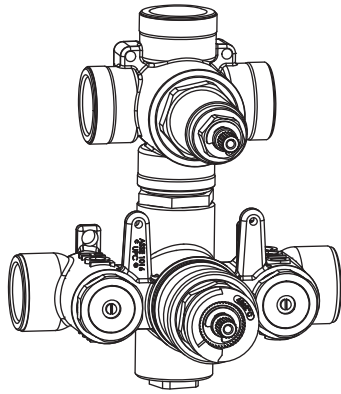

! A separate volume control is **not** needed to turn water supply off. Volume control functionality is integrated within this valve.

CALGreen Compliant



Legislation Compliance



ZeroDrip Technology



Technical Diagram

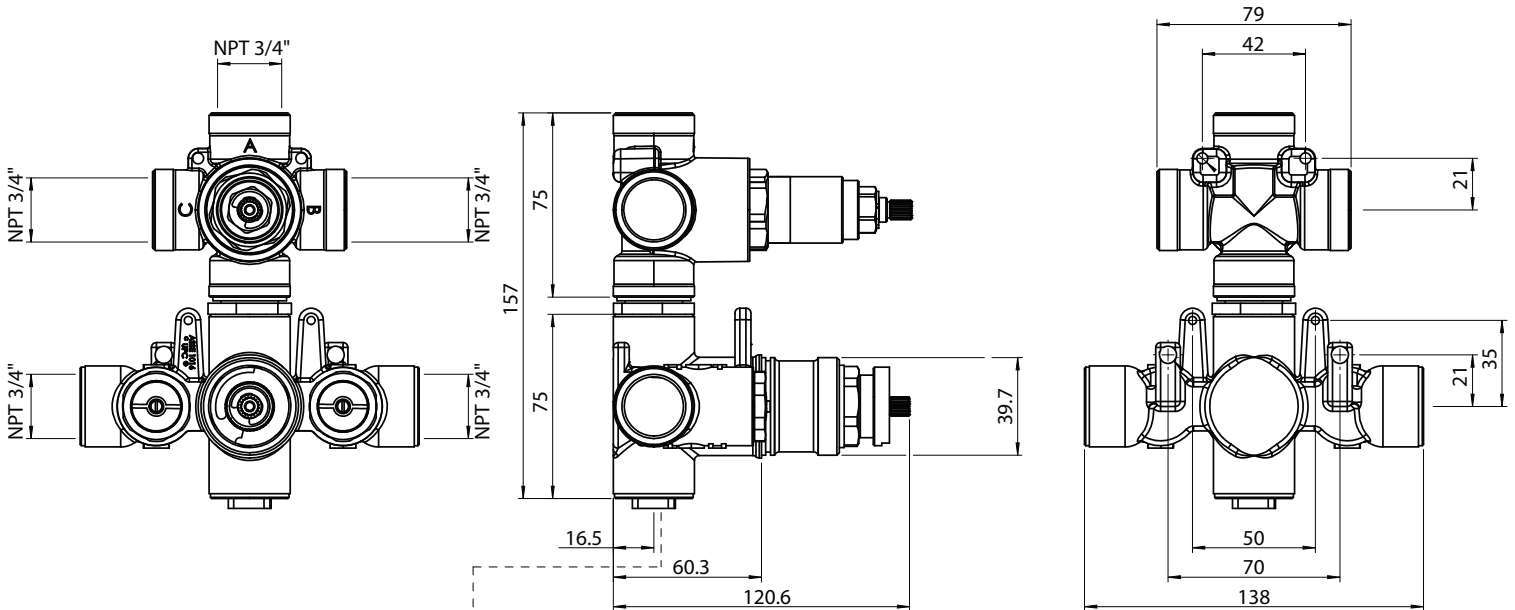

Note: Pre-Installed cap cannot be removed unless a separate volume control or diverter is used

TVH.4301F | 3/4" Thermostatic Valve With 3-Way Diverter & Integrated
Volume Control Page 2 of 2



THREE OUTPUT - CAL-GREEN - NO SHARED PORT OPERATION

Diverter Cartridge # - **15100** (Included)

Total 6 Positions as defined below, with **only** 1 port active at one time.

- Position 0 - Off - No Water Flow
- Position 1 - Output B Activated
- Position 2 - Off - No Water Flow
- Position 3 - Output A Activated
- Position 4 - Off - No Water Flow
- Position 5 - Output C Activated

THREE OUTPUT - SHARED PORT OPERATION

Diverter Cartridge # - **15200** (Not Included)

Total 6 Positions as defined below, with 2 ports active at one time.

- Position 0 - Off - No Water Flow
- Position 1 - Output B Activated
- Position 2 - Output B+A Activated
- Position 3 - Output A Activated
- Position 4 - Output C+A Activated
- Position 5 - Output C Activated

