

# Product Parts Breakdown

▲ Specify Finish

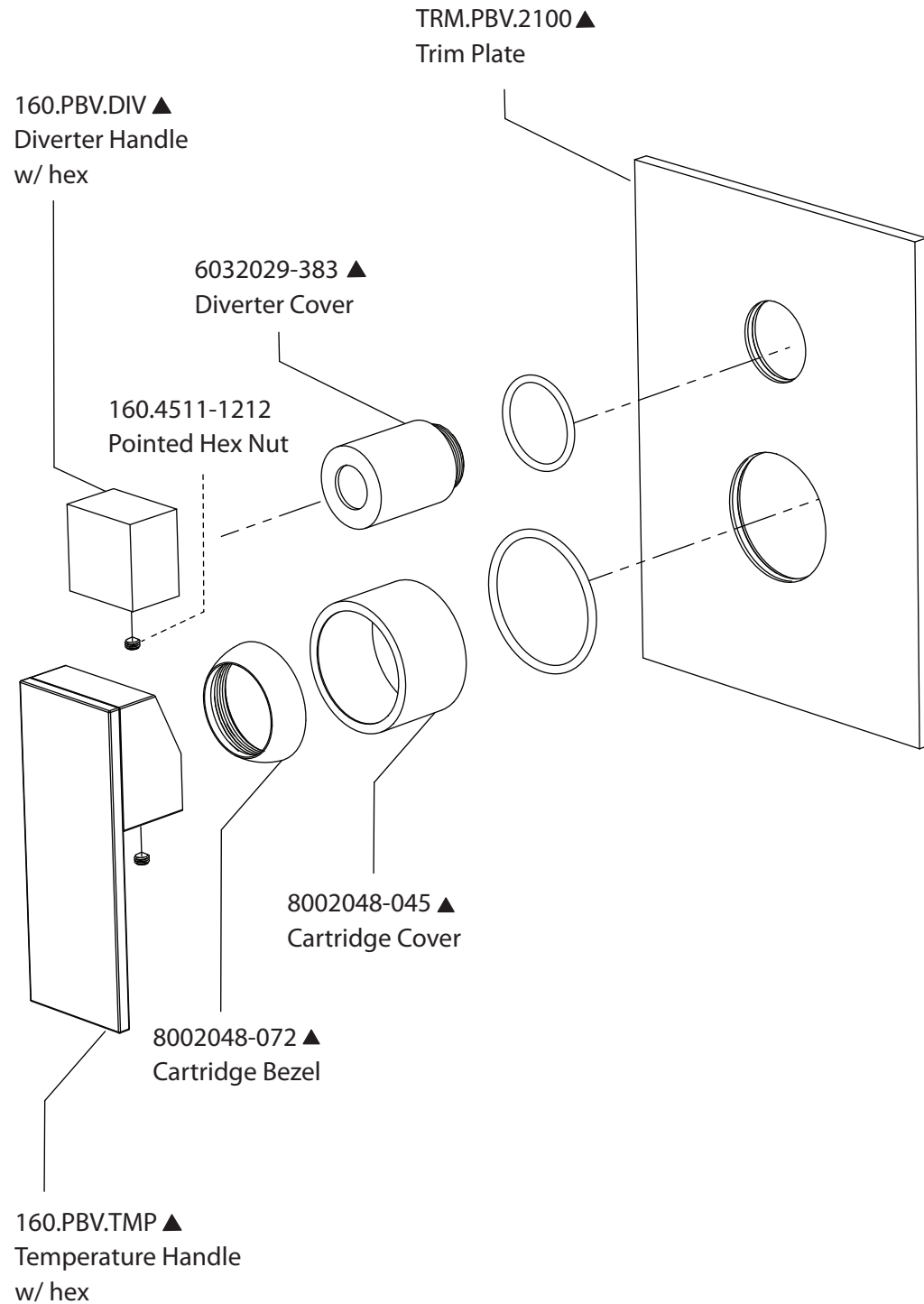

**isenberg**  
innovation+design

160.2101T

Ver 2.58