

Product Parts Breakdown Using TVH.4301F Valve

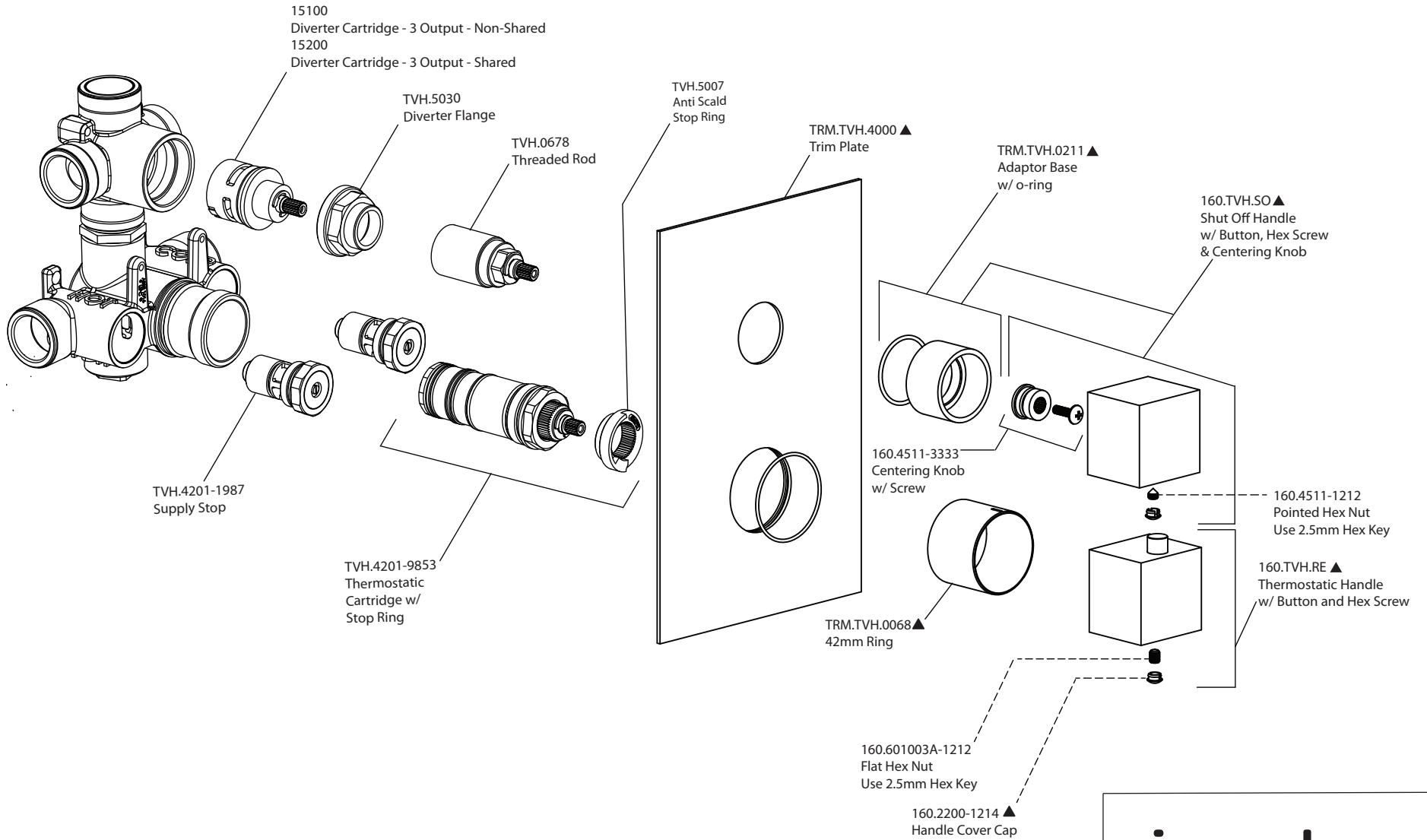

isenberg
innovation+design

160.4301

Product Parts Breakdown Using TVH.4301 Valve

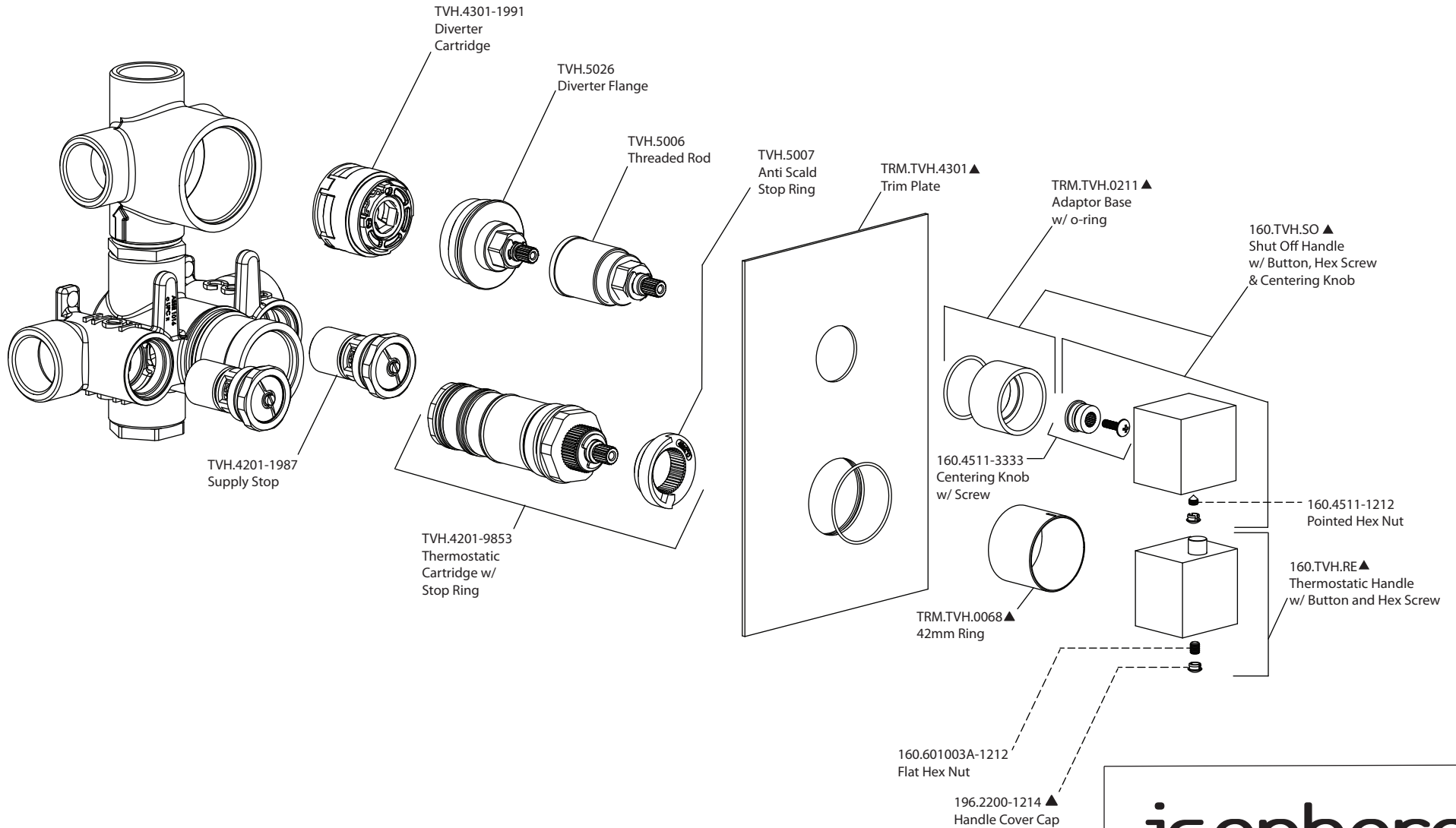

isenberg
innovation+design

160.4301