

Product Parts Breakdown

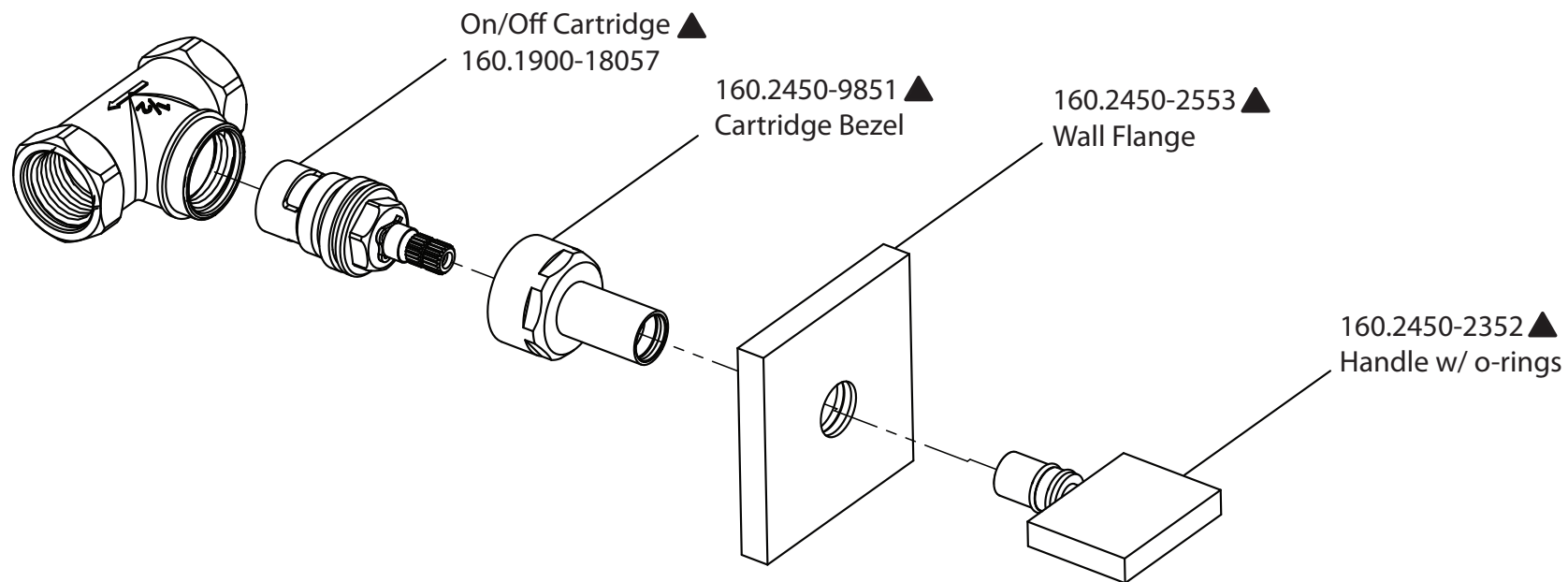

isenberg
innovation+design

160.4510

Ver 2.54