

160.6415 | 1/2" Spin Body Jet With Concealed Valve

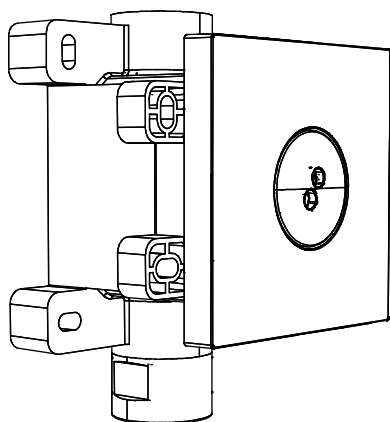

SPECIFICATIONS:

- 1.05 GPM Flow Rate @ 60 PSI
- Includes Concealed In-Wall Valve
- Water spins out.

FAST SHIP FINISHES :

- Chrome - 160.6415CP, Brushed Nickel - 160.6415BN

STANDARDS:

- ASME A112.18.1 / CSA B125.1

Legislation Compliance



ZeroDrip Technology



Technical Diagram

