

Product Parts Breakdown

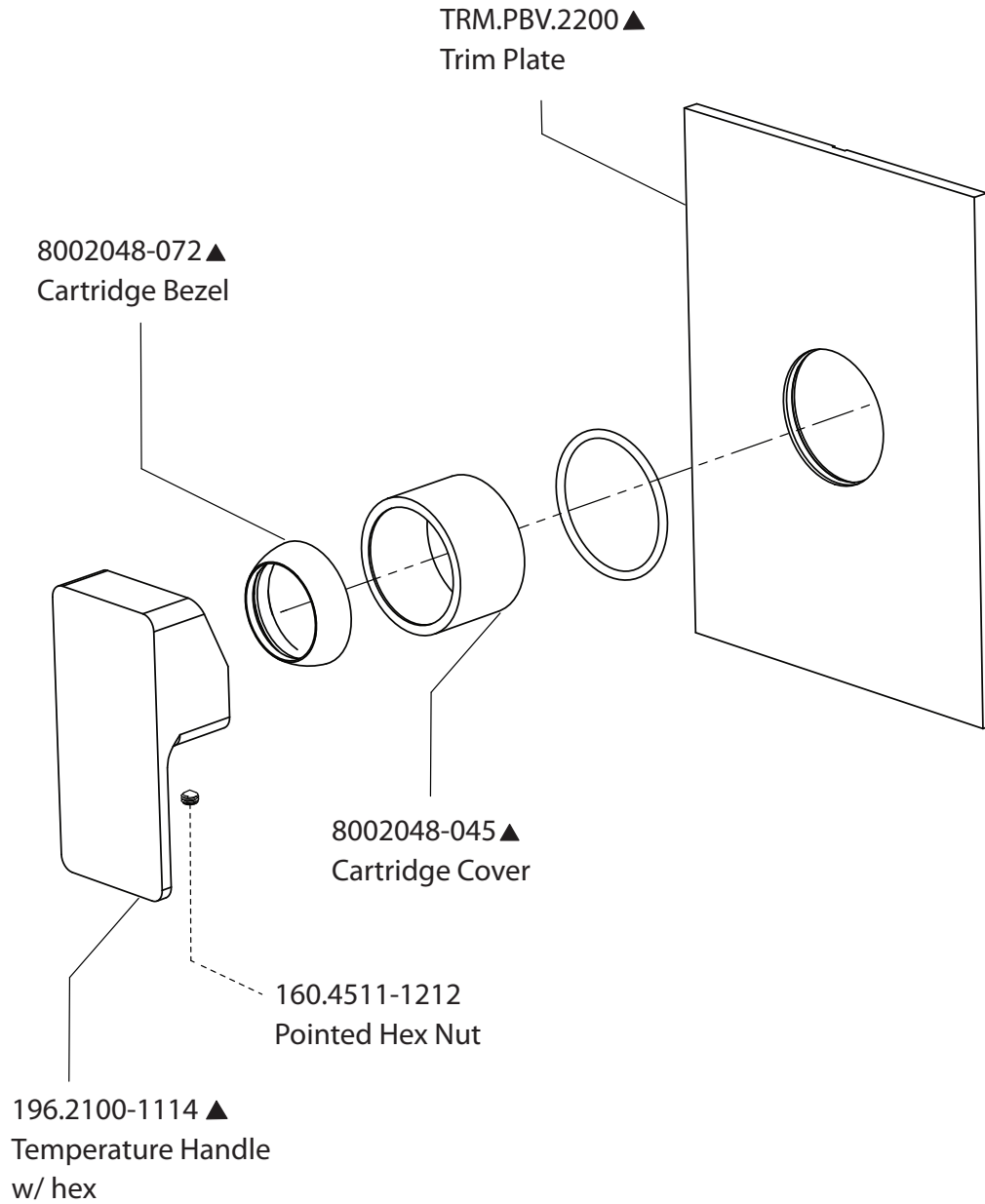

isenberg
innovation+design

196.2200T