

Product Parts Breakdown

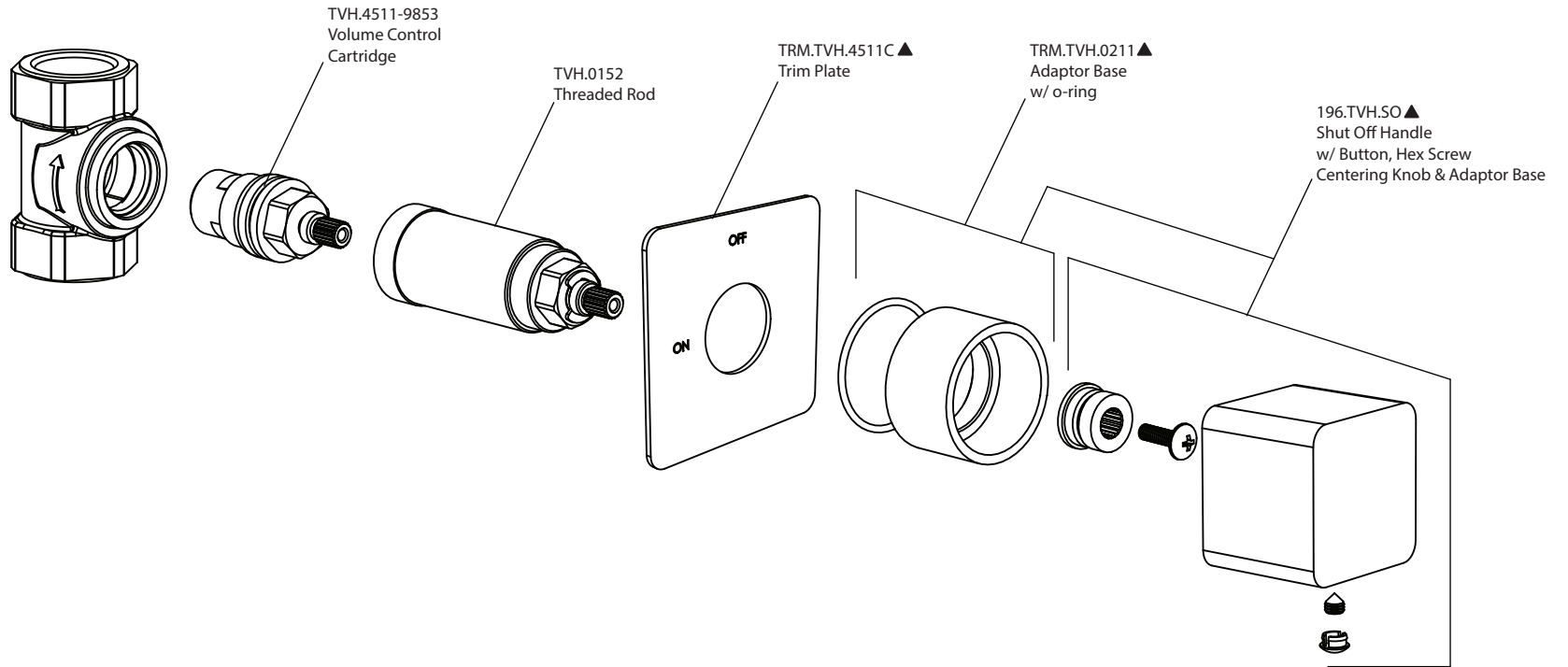

isenberg
innovation+design

196.4511

Ver 2.53