

Product Parts Breakdown

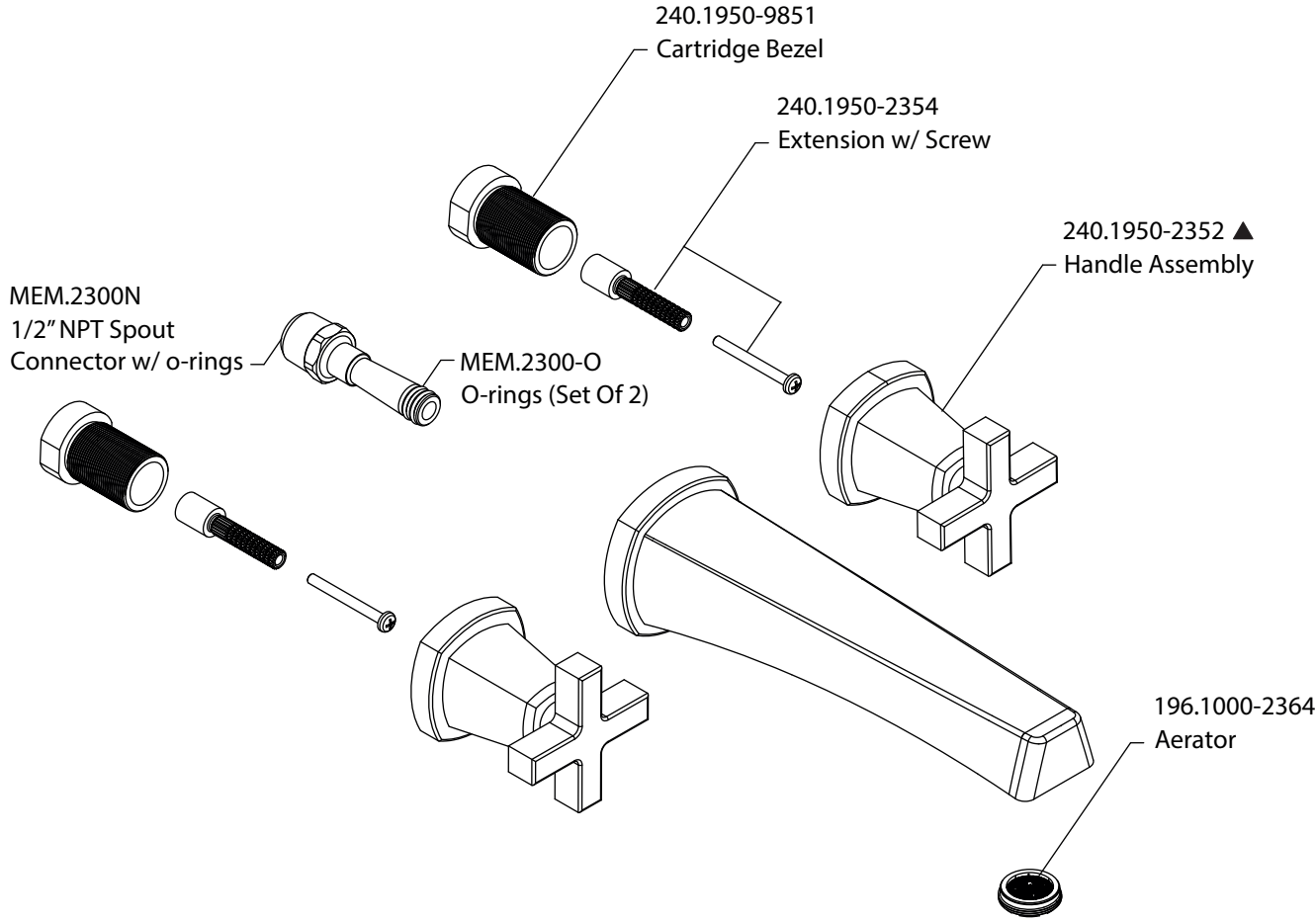

isenberg
innovation+design

240.1950T

Ver 2.54