

Product Parts Breakdown

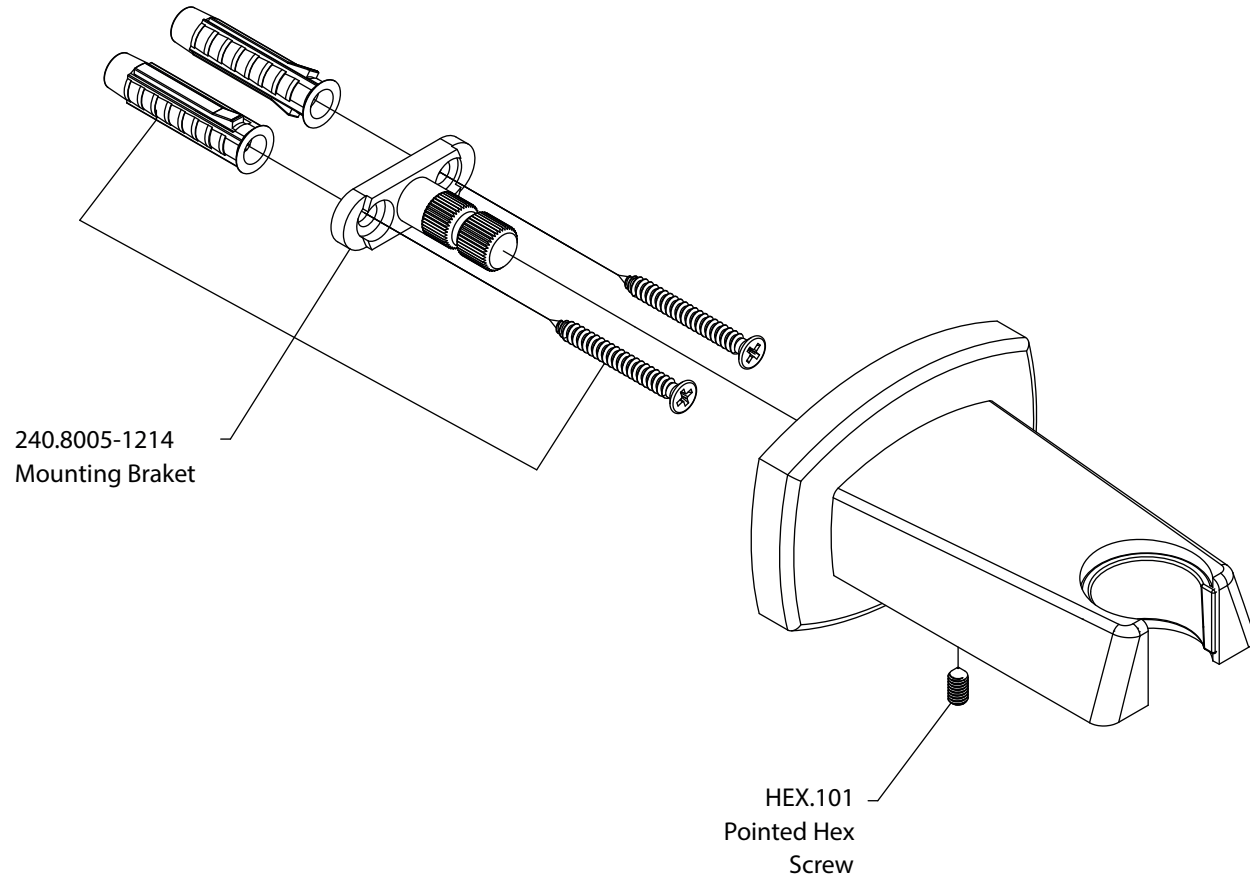

isenberg
innovation+design

240.8005

Ver 2.53