

Product Parts Breakdown

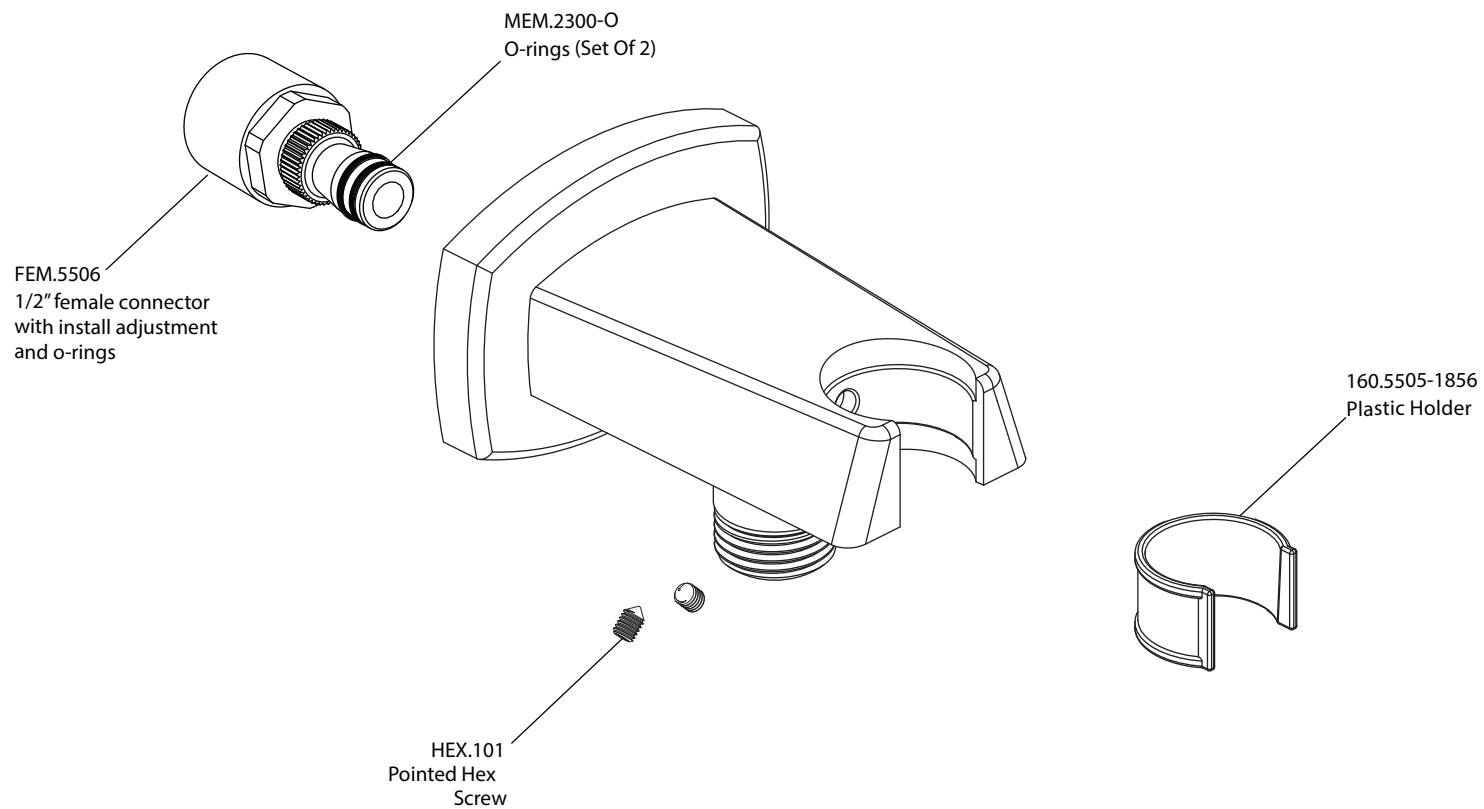

isenberg
innovation+design

240.8006

Ver 2.55