

# Product Parts Breakdown Using TVH.4420F Valve

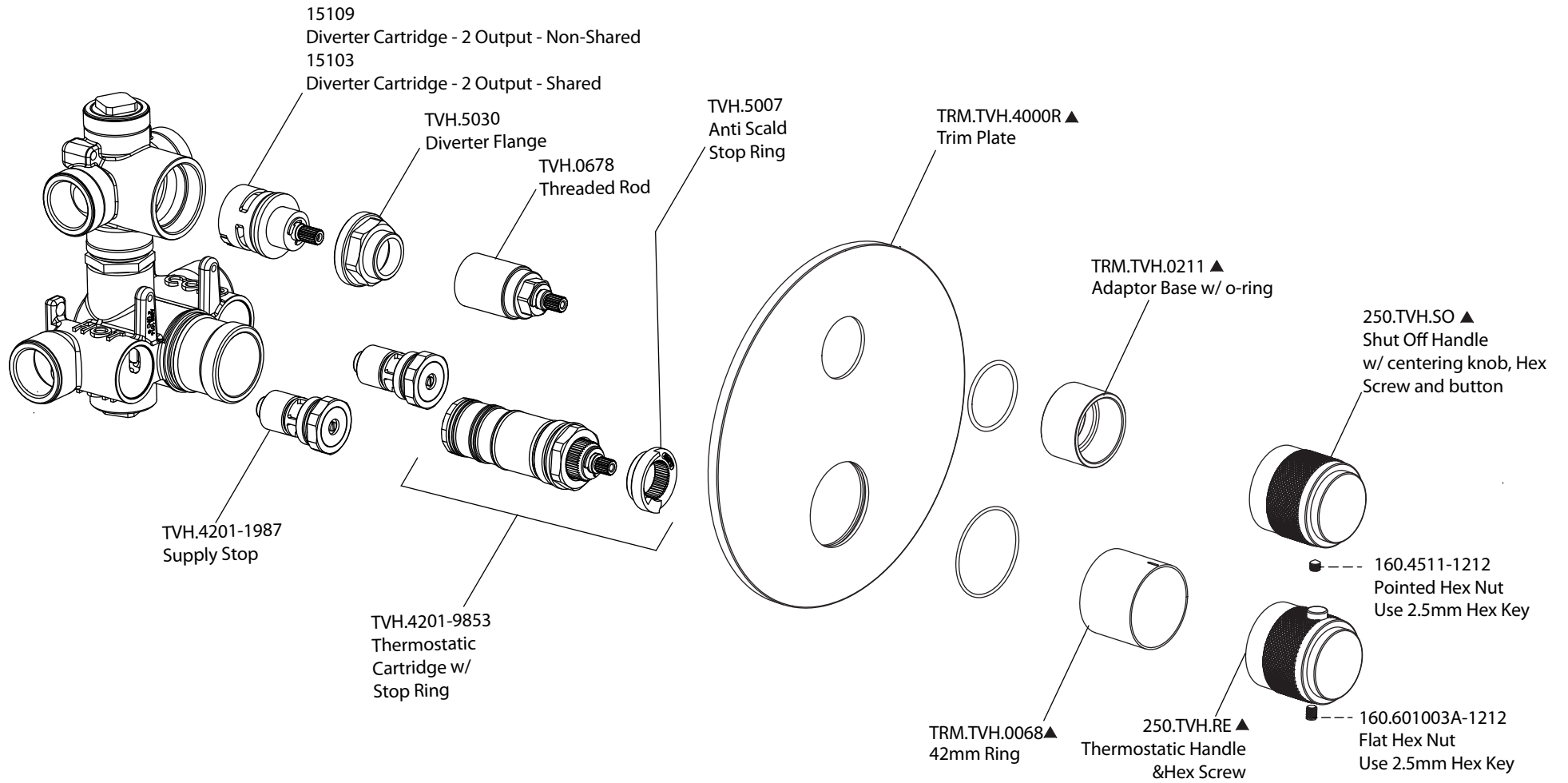

**isenberg**  
innovation+design

250.4420

# Product Parts Breakdown Using TVH.4420 Valve

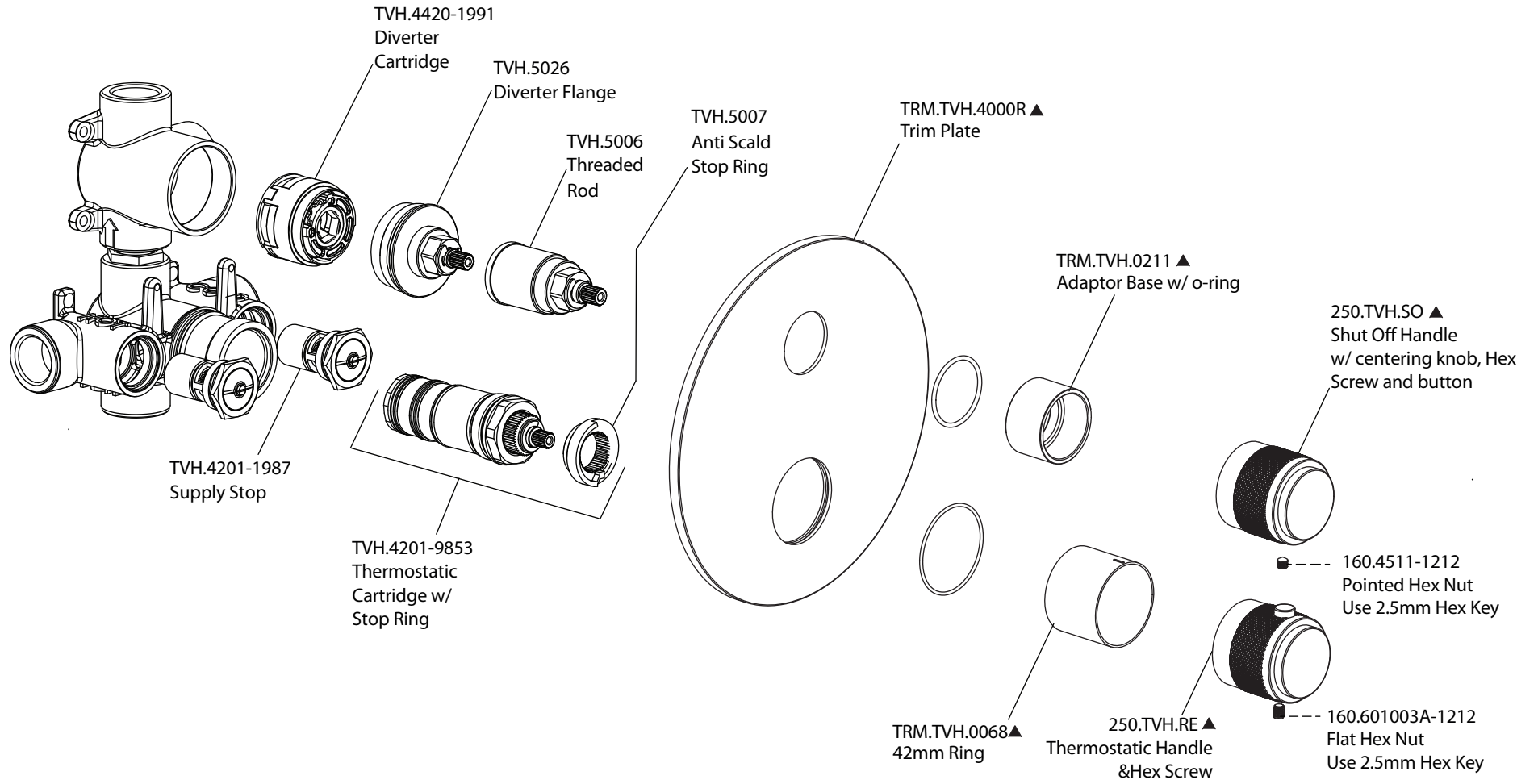

**isenberg**  
innovation+design

250.4420