

light mirror
07896171550 Light mirror

PRODUCT

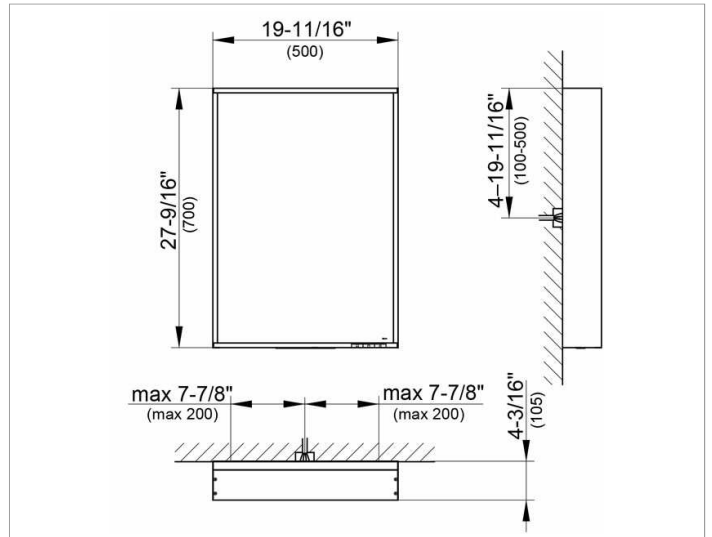

DRAWING



PRODUCT ATTRIBUTES

1 light colour, 3000 kelvin (warm white), continuous aluminium frame, silver anodized

Operation:

key panel with capacitive touch sensor, optionally to be operated via the light switch Illumination.

LED (lifespan > 30 000 hours),

Main light (top light and wall light), and washbasin lighting separately infinitely dimmable and can be switched on/off

EEK: ,

SURFACE

27 watt

Warranty: KEUCO products are covered by a 5-year manufacturer's warranty, in effect from the date of purchase. During this time, proven product defects will be remedied free of charge. Warranty claims must be filed in writing, including a detailed description of the defect immediately after a defect has occurred. For a copy of our detailed product warranty policy, please contact us at office-usa@keuco.com.

Installation: KEUCO products must be installed by a qualified professional in accordance with the respective installation guidelines and any applicable federal / local building codes and regulations.