

**Royal Match**

12812171351 Mirror cabinet

**PRODUCT**



**DRAWING**

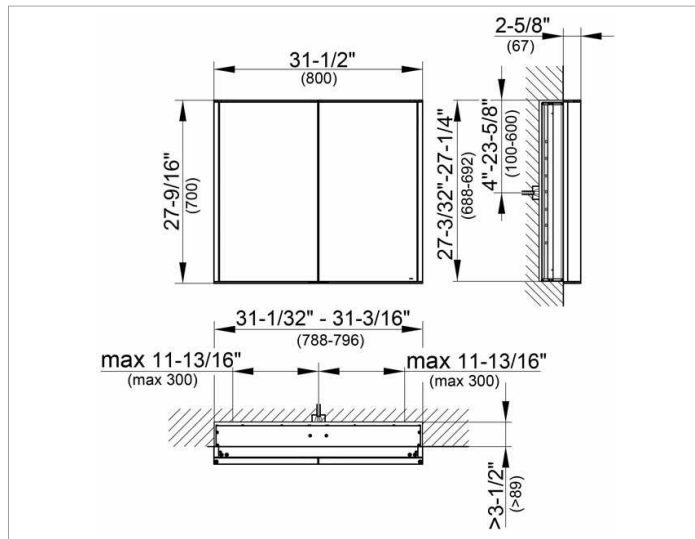

**PRODUCT ATTRIBUTES**

for recessed installation  
 2 hinged double sided crystal mirror doors,  
 body in aluminium silver anodized,  
 rear panel in back-lacquered white glass  
 Operation:  
 control panel with capacitive touch sensor,  
 optional to be operated via the light switch  
 Illumination:  
 LED 2 x 12,5 watt (lifespan > 30.000 hours),  
 light color 3000 kelvin (warm white),  
 infinitely dimmable, lamps non-exchangeable  
 EEK: ,

**EQUIPMENT**

- 2 sockets (internal)
- 2 x 3 adjustable glass shelves
- interior lighting

**SURFACE**

silver anodized

**Warranty:** KEUCO products are covered by a 5-year manufacturer's warranty, in effect from the date of purchase. During this time, proven product defects will be remedied free of charge. Warranty claims must be filed in writing, including a detailed description of the defect immediately after a defect has occurred. For a copy of our detailed product warranty policy, please contact us at office-usa@keuco.com.

**Installation:** KEUCO products must be installed by a qualified professional in accordance with the respective installation guidelines and any applicable federal / local building codes and regulations.