

Shower shelves

2494401000 Sponge basket for corner installation

PRODUCT



DRAWING

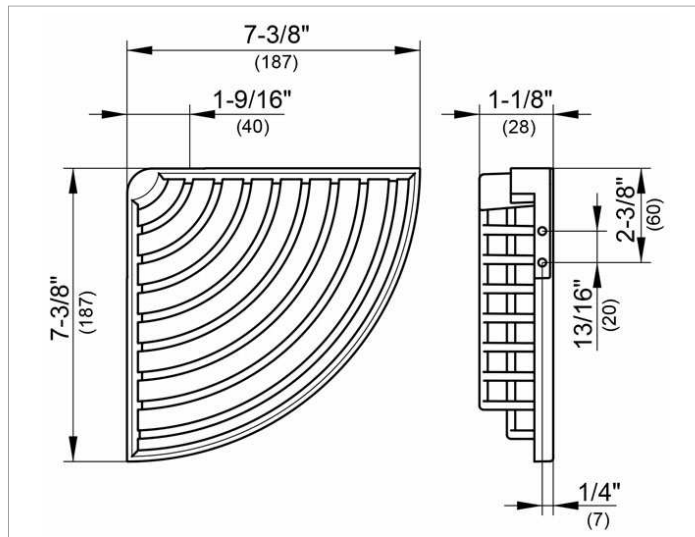

PRODUCT ATTRIBUTES

removable, with concealed fastening screws

SURFACE

polished chrome

SPECIFICATIONS

KEUCO SPONGE WIRE BASKET for corner installation, wall mounted, 2494401000
 chrome-plated sponge wire basket for corner installation in a functional design,
 easy to clean, removable
 leg length 7-3/8", height 1-1/8",
 with concealed fastening screws
 incl. corrosion-free mounting material

Warranty: KEUCO products are covered by a 5-year manufacturer's warranty, in effect from the date of purchase. During this time, proven product defects will be remedied free of charge. Warranty claims must be filed in writing, including a detailed description of the defect immediately after a defect has occurred. For a copy of our detailed product warranty policy, please contact us at office-usa@keuco.com.

Installation: KEUCO products must be installed by a qualified professional in accordance with the respective installation guidelines and any applicable federal / local building codes and regulations.