

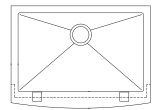

## Installation Guide

### Handmade Stainless Steel Farmhouse Kitchen Sink



K1-SF30

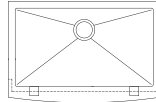

K1-SF33

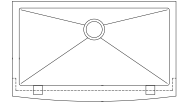

K1-SF36

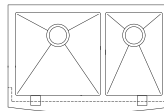

K1-DF33

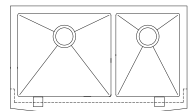

K1-DF36

# Installation

---

## General Recommendations:

- 1- Read the instruction carefully before installation. Inspect the sink prior to installation to make sure that is not been damaged during shipping.
- 2- The instructions are for installation with solid surface and composite material countertops. KIBI recommends professional stone fabricator to perform the installation and is not responsible for damage to countertop or sink during installation.
- 3- Template are only provided as a guide. Place template on sink to ensure the template will give you the proper cutout for the sink.
- 4- Observe all local plumbing and building codes.
- 5- Keep this booklet and the receipt (or other proof of date and place of purchase) for this product in a safe place. The receipt is necessary to request warranty parts.
- 6- KIBI does not accept any liability for damage to countertop, sink fixture, faucets or personal injury during installation. Warranty is void if installation guide is not followed.

**Please keep the box and packaging materials until your product is completely installed.**

**NOTE: These sinks are intended for indoor kitchen use only. They are not rated for outdoor use. Installation of this sink in an outdoor setting will void any warranty on this product.**

## Tools you may need



Drill

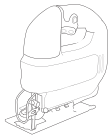

Jig Saw

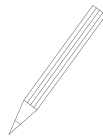

Pencil



Phillips Screwdriver

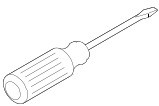

Screwdriver

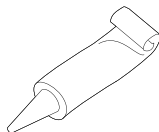

Silicone sealant

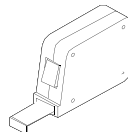

Tape Measure

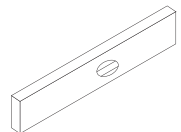

Level

---

## Determine Reveal Type

KIBI Farmhouse sinks can be installed in three different types:

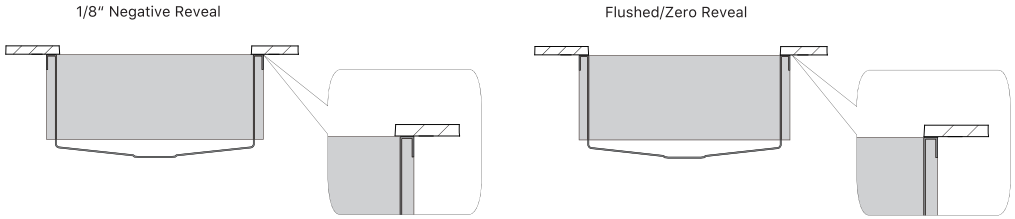

KIBI Recommended installation type

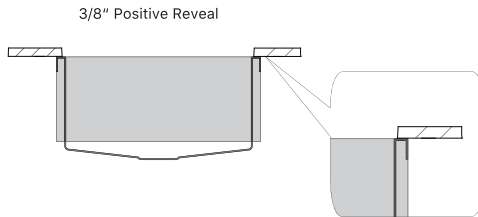

**Caution:** When determining sink placement, be sure to check that there is adequate clearance behind the sink for any faucet(s) and your backsplash, as well as clearance for a full range of motion for faucet spouts and handles.

**NOTE:** Contact your retailer if any product is damaged or missing prior to installation. Never install a damaged sink as it can void your warranty.

# Installation

1

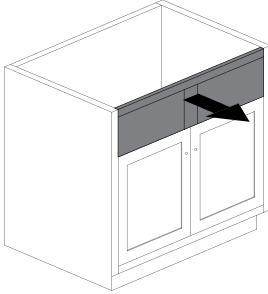

Prepare the sink base cabinet. Measure the actual height of apron, Add 1/16" to the dimension when you mark base cabinet front cutout.

2

Supports

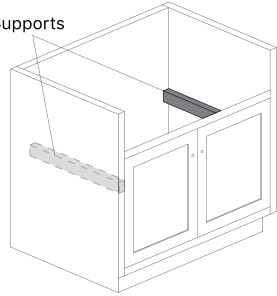

Build structural supports on the inside frame of the sink base cabinet. The structural supports must support the weight of the sink and any attachments such as garbage disposals.

3

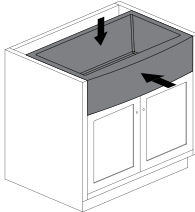

Make template and cutout. Due to the various cutout sizes (based on your preference), A cutout template is not provided. Use the actual sink measurement to determine the actual location of the cutout. Ensure adequate clearance behind the sink for any faucet and backsplash.

4

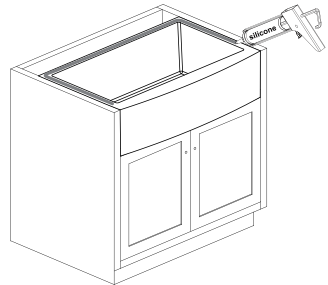

Set the sink on top of the cabinet or into the cabinet front cutout. Apply sealant if necessary as a gasket between the sink and cabinet.

⚠ **Do not use epoxy.**

5

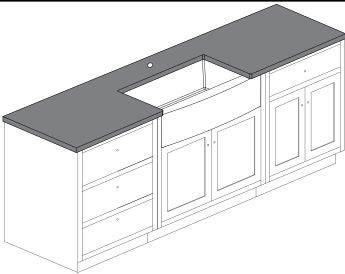

Carefully clean bottom of countertop and top edge of sink with denatured alcohol. Apply a bead of silicone adhesive (not supplied) around the top edge of the sink. Place countertop onto the sink.

6

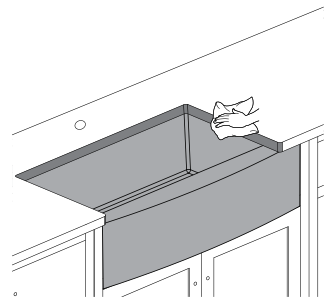

Remove excess sealant from the lip of any surfaces with a cleaner recommended by manufacture of adhesive sealant.

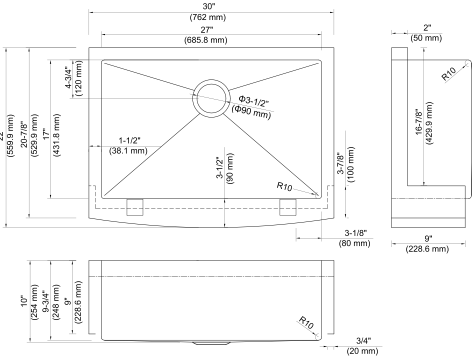

**K1-SF30**  
**30"x22"x10"**  
**Min Cabinet Size: 30"**

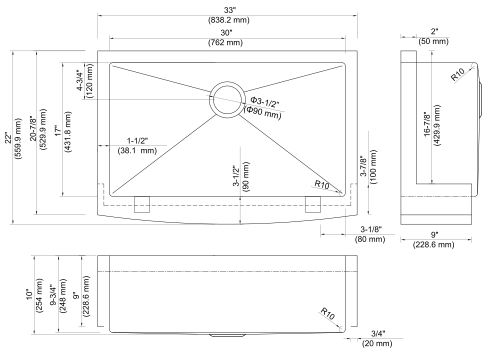

**K1-SF33**  
**33"x22"x10"**  
**Min Cabinet Size: 33"**

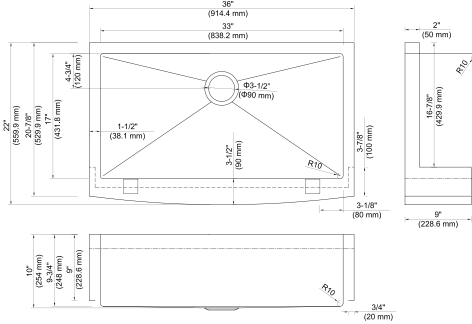

**K1-SF36**  
**36"x22"x10"**  
**Min Cabinet Size: 36"**

# Dimensions

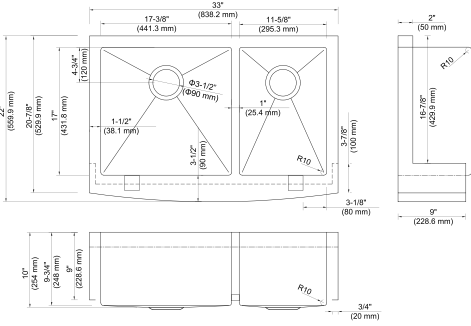

**K1-DF33**  
**33"x22"x10"**  
 Min Cabinet Size: 33"

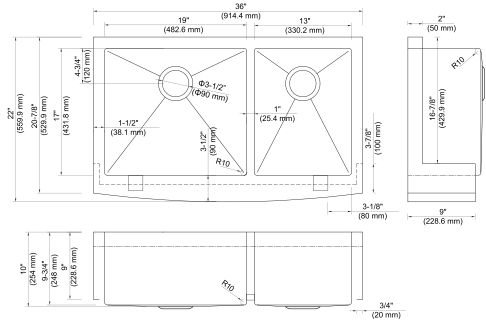

**K1-DF36**  
**36"x22"x10"**  
 Min Cabinet Size: 36"

If you've followed the instructions carefully and your sink still does not work properly, take these corrective steps.

Trouble - Shooting	
PROBLEM	ACTION
Scratches	Use a nylon pad with an iron-free abrasive polishing compound. Follow the direction of the original brush lines and the scratch will disappear as it's blended into the original finish. Be careful to not polish too aggressively since you'll polish out the original brush lines and end up with a shiny spot.
Water deposits	Regular routine cleaning can usually prevent lime scale deposits from hard water. Do not allow excessive build up before treating. Soaking in a 25% vinegar solution or a 5% nitric acid solution can remove these hard water spots. Periodically rub with a nylon-bristled brush or a fine-mesh synthetic scouring pad. Rinse and towel dry after treatment.
Rust marks	If rust marks develop due to presence of, or contact with, ferrous (iron-containing) materials, swab with a sponge wetted with a diluted (10-15%) solution of nitric acid (HNO <sub>3</sub> ) and follow with routine cleaning. Avoid prolonged contact of ferrous materials (like cast iron pans) with stainless steel. Nitric acid in dilute concentrations (<20%) is the only acid that is safe to use on stainless steel.

---

## Care & Maintenance

Clean regularly with normal detergent and warm water.

Always make a habit of drying your sink after use and buffing with a soft cloth. This will ensure that no build up of limescale or other mineral deposits can occur.

Clean the sink once a week using a non-abrasive cleanser such as Comet and a clean soft sponge. Scrub in the same direction as the natural grain of the sink.

**Never let soap or other household cleaners to dry on the surface of the sink. Most products contain additives which will affect the finish of the sink.**

**Never use bleach solutions on the sink, as it is harmful to stainless steel. If left on the sink too long it can cause surface pitting.**

**Never use a steel wool pad to clean your sink. Doing so may damage the sink's surface and cause discoloration.**

Minor scratching of the sink's surface is extremely difficult to avoid and is not something to be unduly concerned about. These marks are usually only superficial and can be removed with a proprietary stainless steel cleaner.

Use of rinse grids will reduce exposure of the bottom of the sink to scratches.

## Limited Lifetime Warranty

This product has been manufactured and inspected to the highest possible quality standards. Kibi sinks carry a limited lifetime warranty for residential use.

Should you experience any defects in materials or workmanship within the warranty period, we will repair or replace the defective product, subject to the following conditions:

- Any claim made under this warranty must include a copy of a valid proof of purchase showing the date and place of purchase.
- Our obligation under this warranty is to the original purchaser only, and may not be transferred.
- Product replacement does not include shipping costs or labor installation costs.
- This warranty applies to residential installations only.
- Kibi reserves the right to examine product in question and its installation prior to replacement.
- If an identical replacement product is not available, Kibi reserves the right to replace the defective product with a similar product.

NOTE: Accessories such as rinse grids, cutting boards, strainers are not covered by this warranty.

This warranty relates to defects in manufacture, materials or workmanship in a Kibi stainless steel kitchen sink supplied for installation into domestic premises in the United States. It does not extend to :

- Damage resulting from failure to maintain the product in accordance with the Care and Maintenance instructions in this manual.
- Normal wear and tear, scratches or accidental damage.
- Faults arising from improper use and/or installation.
- Defects in accessories, strainers and rinse grids.

**All incidental or consequential damages are specifically excluded. No additional warranties, express or implied are given, including but not limited to, any implied warranty of merchantability or fitness for a particular purpose.**

Some states do not allow the exclusion or limitation of incidental or consequential damages or limitations on how long an implied warranty lasts, so the above limitations or exclusions may not apply to you.

This warranty gives you specific legal rights, and you may also have other rights which vary from state to state.