

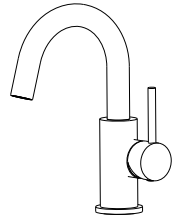

Installation Guide



Circular
KBF1021

DIMENSIONS

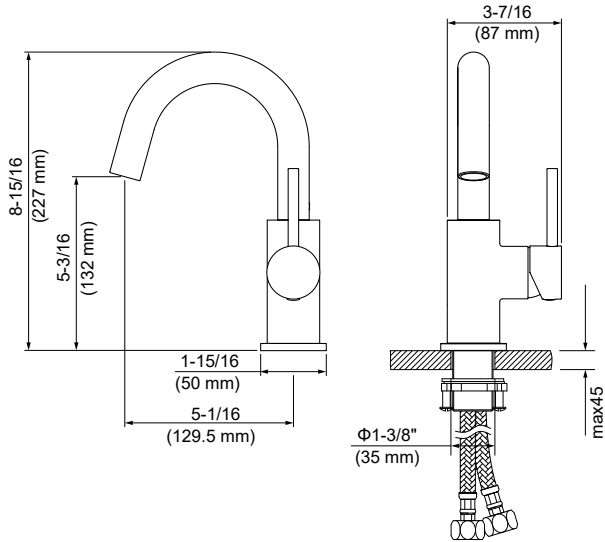

PARTS

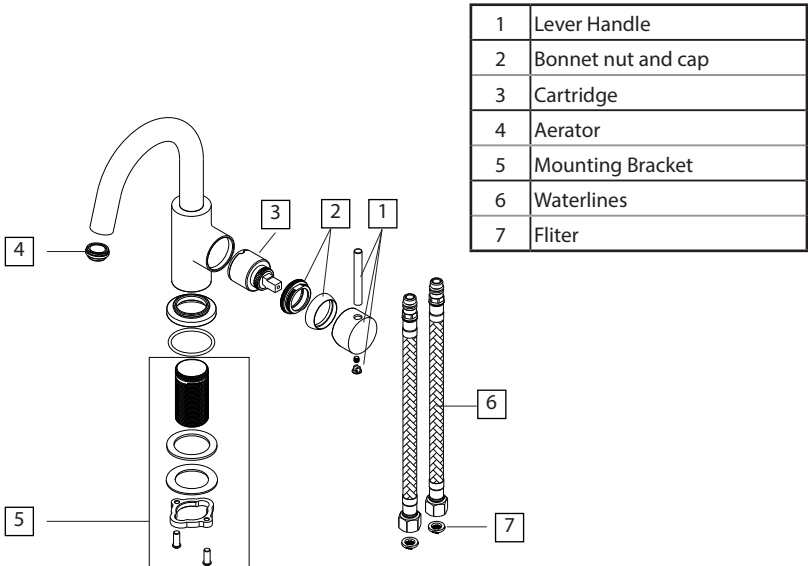

1

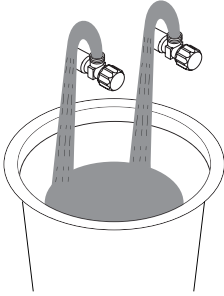

Shut off water suppliers. Remove the old faucet, clean the mounting surface.

Note: For first time install, flush the pipes first by open the angel valve to run 60s.

2

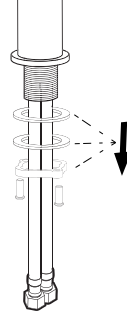

Remove the mounting hardware from the mounting pipe.

3

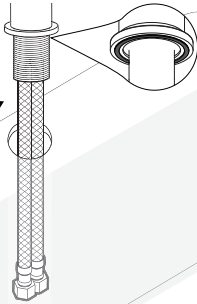

Put the rubber O-ring into the bottom gap of faucets then Insert faucet into faucet hole.

4

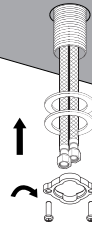

From below the sink, Slide rubber washer, metal washer and mounting bracket onto the thread shank.

5

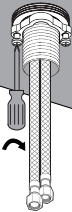

Adjust position of faucet body if necessary, Then tighten the mounting nuts with phillips screwdriver until snug.

6

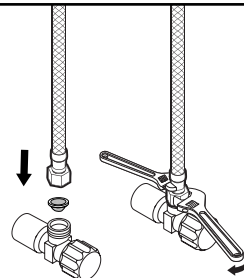

Connect and tighten the supply hoses by using two adjustable wrenches (avoid twisting or kinking). Turn on the angle valve and check for leaks.

Note: Do not remove the net filter that attached into the connecting end!

TROUBLE SHOOTING

If you've followed the instructions carefully and your faucet still does not work properly, take these corrective steps.

Problem	Cause	Action
Low flow	Aerator or filter may be clogged	Unscrew aerator to check rubber packing or replace aerator. (Note: some models require wrench to remove aerator.)
Faucet leaks from under handle	Bonnet nut has come loose or cartridge needs to be reseated	Remove handle and cap. Using a wrench, ensure bonnet nut is tight.
Water will not shut off completely.	Dirty or worn out plastic washer in the cartridge.	Adjust or replace cartridge. WARNING: Failure to securely tighten bonnet nut with a wrench could result in water damage.

CLEAN AERATOR AND FLITER

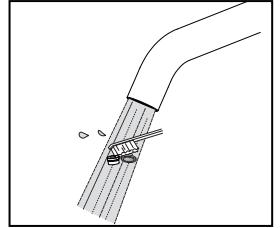
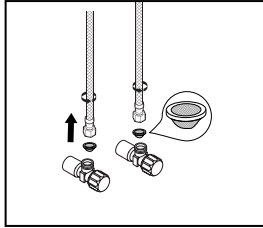
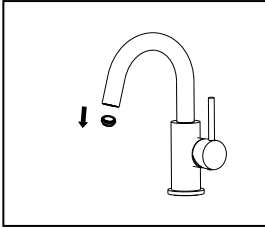

CLEANING AND CARE

Clean the faucet often with a soft cloth to keep it looking like new. For heavy cleaning you can use mild liquid detergents or non-abrasive liquid polisher. Rinse with water and dry with a soft cloth. Avoid abrasive cleaners, steel wool and harsh chemicals as these will dull the finish and void your warranty.

LIMITED LIFETIME WARRANTY

KIBI provides its customers with an extensive warranty as a result of our excellent workmanship and high quality components used in our products.

Mechanical warranty: A limited lifetime warranty is provided on all mechanical parts to be free from manufacturing defects in materials and workmanship under normal use for as long as the original purchaser owns their home.

Finish warranty: A 5-year warranty is provided on all KIBI faucet finishes to the original purchaser against manufacturing defects in materials and workmanship.

At its sole discretion, KIBI will repair or replace any part or finish that proves to be defective in material and/or workmanship under normal installation, use and service.

This warranty is extended to the original consumer owner, but does not cover installation or any other labor charges. In no event shall KIBI be liable for any incidental, consequential or special damages, installation cost, labor, travel time, freight costs incurred, lost profits, or contingent liabilities. KIBI makes no representation that its products comply with any or all local building or plumbing codes. It is the consumer's responsibility to determine local code compliance.