

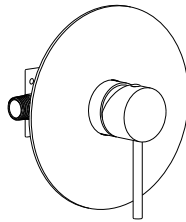

Installation Guide

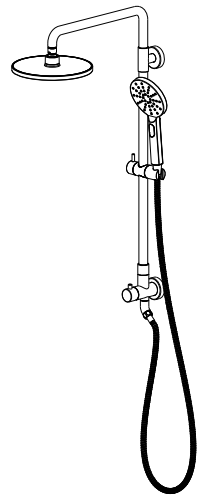

Shower valve
KSV101



Shower Column
KSC401
(Sold Separately)

Installation Instructions

 **READ ALL INSTRUCTIONS BEFORE UNPACKING THE PRODUCT** 

Important

- 1- For best results, we recommend that this unit be installed by a licensed, professional plumber.
- 2- Please read over these instructions thoroughly before beginning installation. Make sure that you have all tools and supplies needed to complete the installation.
- 3- Keep this booklet and the receipt (or other proof of date and place of purchase) for this product in a safe place. The receipt is required should it be necessary to request warranty parts.
- 4- Please keep the box and packaging materials until your product is completely installed and functional.
- 5- Do not return to the store if problems, Contact Customer Service ASAP at 855-883-0888 or email support@kibus.com to get help.

Caution: Always turn off the water before disassembling the valve. Open valve handle to relieve water pressure and to ensure that complete water shut-off has been accomplished.

Flushing

Important: Before closing wall openings, pressure test valve and complete system using flushing instructions.

Pipe chips, sand and other solids found in and renovated plumbing can damage the sealing surfaces of the cartridge, causing leakage or spool blockage. To avoid damage, **DO NOT TURN ON SUPPLY VALVES** until instructed.

Tools you may need



Drill



Screwdriver



Safety Glasses



Wrench

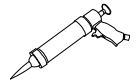

Silicone Caulk Gun

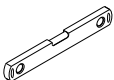

Level



Pencil



Plumbers tape



Tape Measure

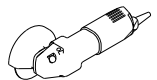

Angle Grinder

Valve Installation Instructions

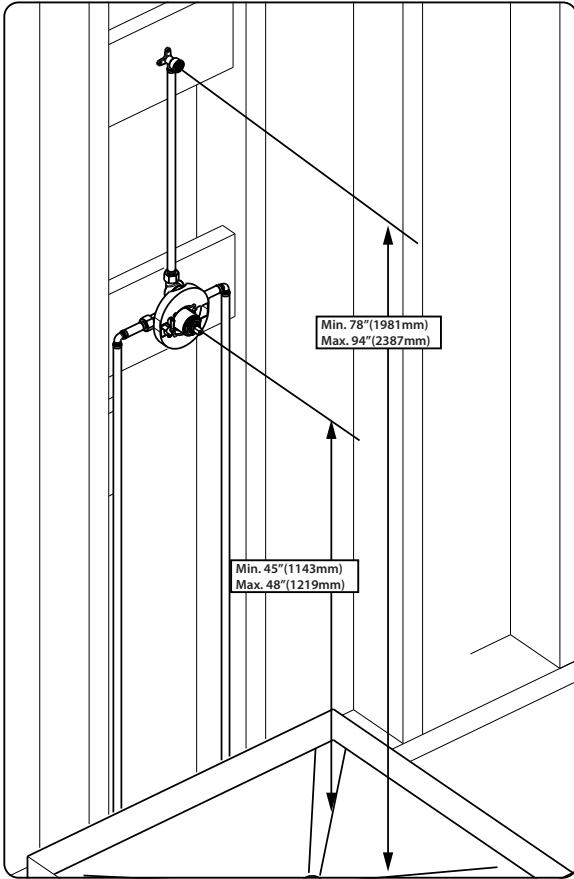

Installation Schematics – Measuring for Ideal Tub/Shower Performance

Installation of this product at non-recommended measurements may lead to issues such as water discharge from the showerhead during tub fill mode.

The shower arm should be placed 78-94 inches above the floor of the tub basin. (Follow shower arm instruction for proper threaded adapter installation).

Position the valve body 45-48 inches from the floor of the tub basin. (Follow valve instruction for proper valve body installation).

Parts of Valve

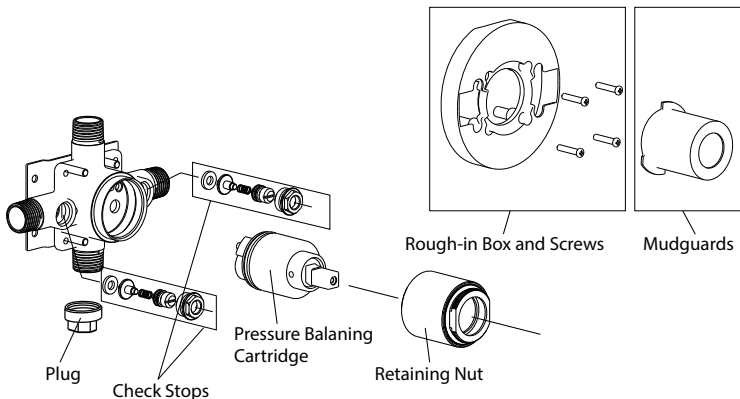

Valve Installation Instructions

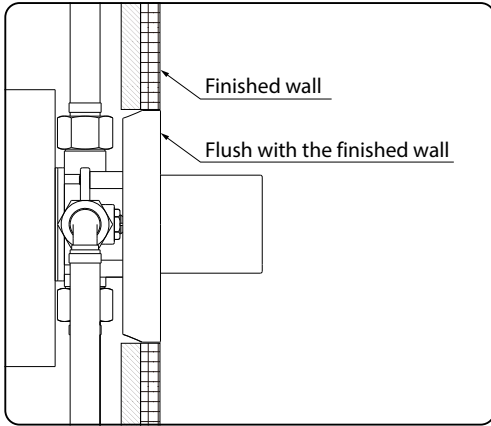

SHUT OFF WATER SUPPLIES. Consider the type and thickness of your finished wall before placing your stringer back plate.

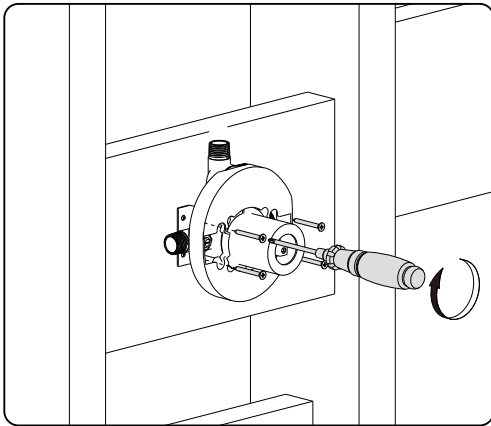

Install the body so the surface of the finished wall is flush with the front of the rough-in box. Make sure the word "UP" are on top of the valve body when installing.

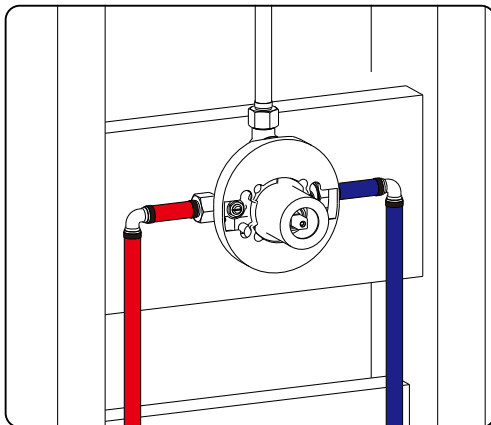

Connect the valve body to water supplies using proper fittings (copper tubing, iron pipe or PEX).
Note: For PEX, be sure to use the right fitting for crimping and the right tool for cold expansion.
If any of the three outlet ports is to be unused, seal the port with a pipe plug.
Note: Left is the hot inlet port and right is the cold inlet port.

If you are making a back-to-back or reverse installation (hot on the right and the cold on left) install the valve body as described, but the water supply lines will be reversed.

Note: Right is the hot inlet port and left is the cold inlet port.

Valve Installation Instructions

For 1/2" Copper Tube Soldering

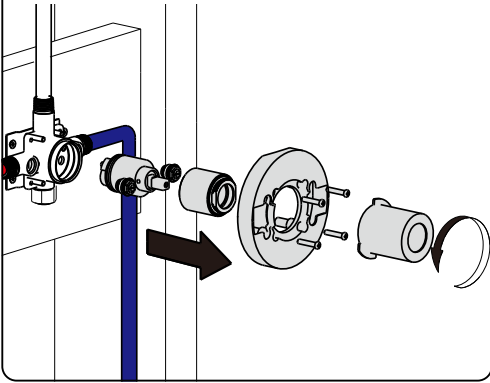

Solder water supply tube to the valve body.

Note: Prior to soldering remove check stops, pressure balancing cartridge and diverter cartridge. Remove check stops by loosening hex nut counterclockwise. Remove the pressure balancing cartridge and diverter cartridge by unscrewing retaining nut with an adjustable wrench. Avoid soldering excessively at high temperature.

Flushing

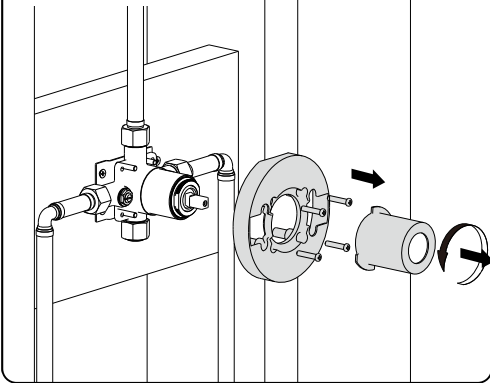

Remove two round mudguards by turning counterclockwise.
Remove the rough-in box.

Flushing

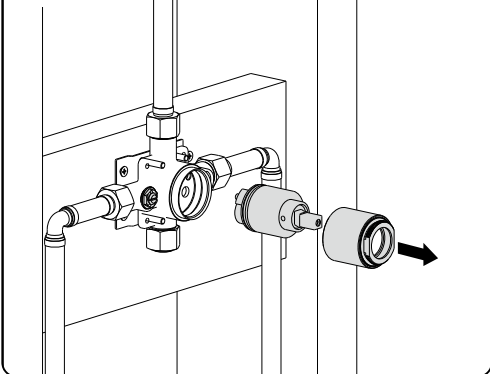

Remove pressure balancing cartridge by unscrewing retaining nut with an adjustable wrench. Slowly turn on both hot and cold supplies and flush out the valve body and lines. Close the check stops and reinstall the cartridge.

Valve Installation Instructions

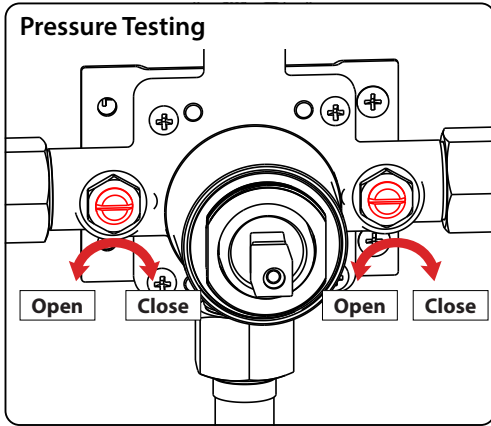

With both check stops in the fully OPEN position, turn on cold and hot water supplies and conduct a system water pressure leak test.

Note: To protect the valve, keep mudguards and rough-in box on during installation. Remove only when you are ready to install trims.

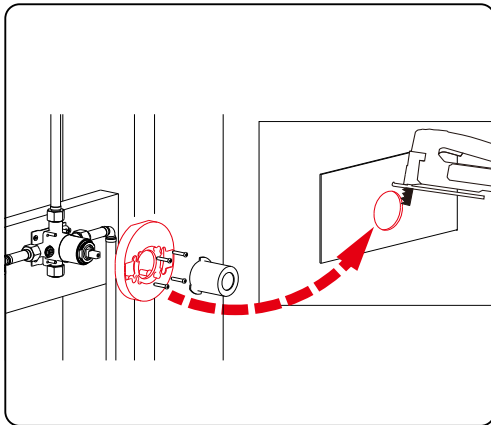

Use the rough-in box as a template to cut the wall properly.

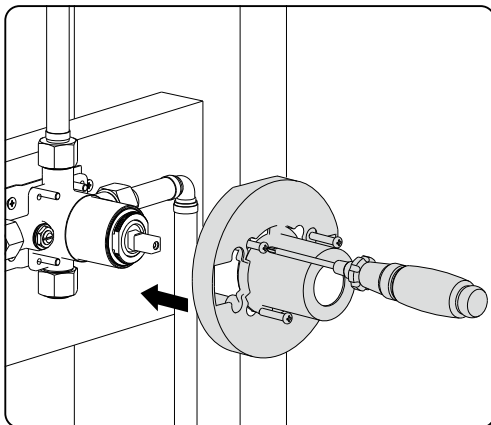

Reinstall rough-in box, two round mudguards by turning clockwise and complete the wall finish installation.

Note: In keeping with standard plumbing practices it is essential that all tub/shower systems be tested extensively for leaks before the finishing wall, (tile, etc.) is completed. Also ensure that the check stops are exposed, (not covered by tile, boarding etc.) under the removable trim plate. The trim plate should completely cover the rough-in opening when attached. (Having access to these stops allow you to stop the water flow to your shower system without turning off the water to the rest of the bathroom or home.)

Trim Installation Instructions

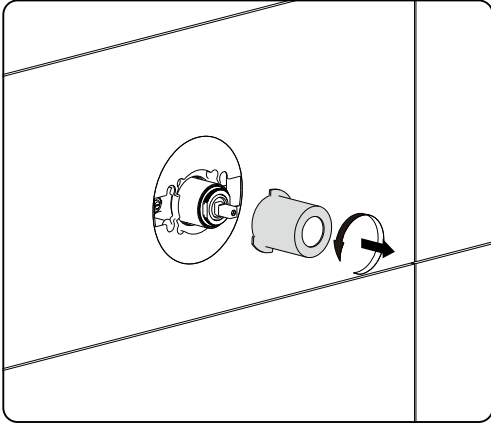

Remove two round mud guards by turning counter-clockwise and discard.

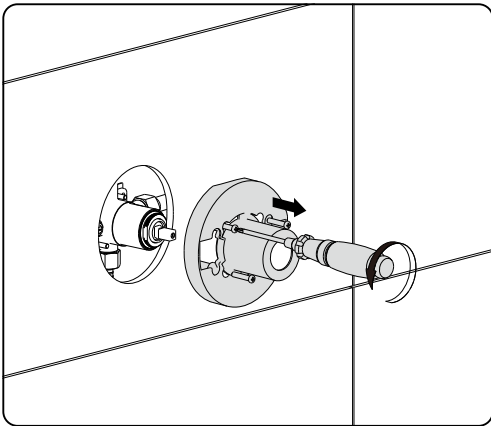

Remove the rough-in box and discard.

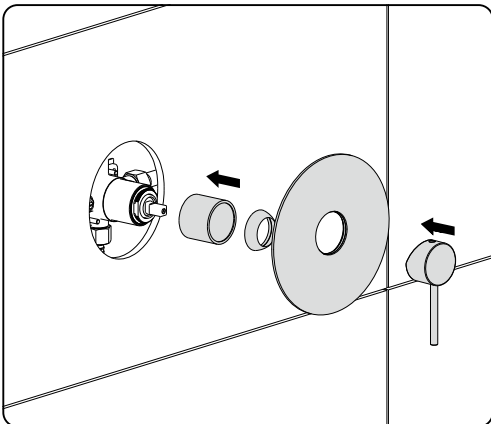

Screw small decorative tube over the diverter valve and slide large decorative tube and cartridge cover onto the pressure balancing valve. Use water to wet the round rubber gaskets on the cover plate and slide cover plate over two decorative tubes. Gently press cover plate against the finished wall. Install cartridge handle and diverter handle. Secure by tightening set screw by using the supplied Allen Wrench. Cover the hole with the supplied plug.

Cleaning and Maintenance Instructions

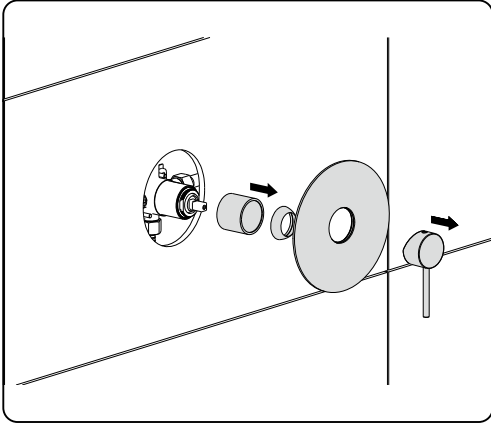

Remove cartridge handle, diverter handle and trim panel.
Remove the decorative ring and decorative sleeve tube.

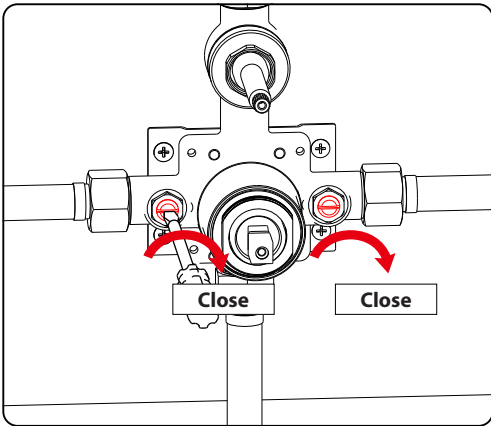

Using light force only, turn 2 check stops clockwise to close the check stops with the flat head screwdriver, until you feel resistance, the check stops are in the closed position.

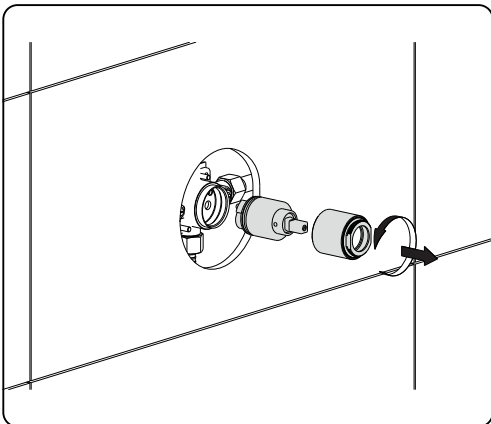

Remove the retaining nut using an adjustable wrench. Use two fingers to grasp the stem of the cartridge and wiggle, then pull out. Shake cartridge and ensure that a clicking sound is heard, which means the pressure balancing spool moves freely and works properly. You may soak the cartridge in 50-50 vinegar/water mix to remove any calcium and mineral build-up. Replace the cartridge if it is damaged.

Shower Column Installation Instructions

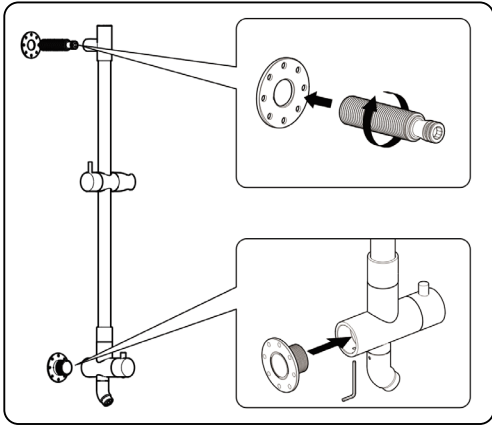

Hand tighten upper mounting flange onto inlet fitting.
Insert the lower mounting post into the lower post of the shower column tighten hex screw with hex wrench supplied.

Note: Shut off water suppliers.

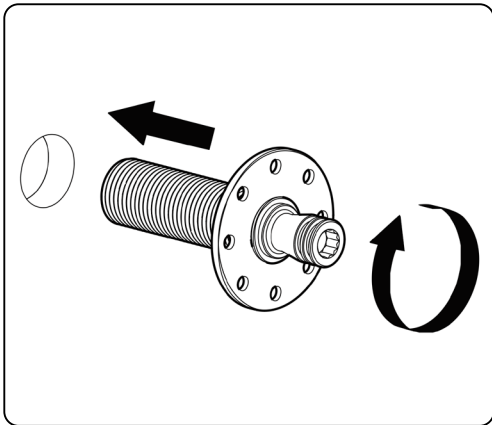

Thread the inlet fitting into the built-in pipe outlet and hand tighten.

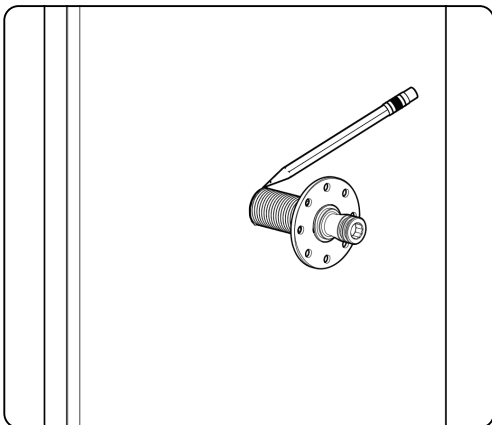

Place mark on existing inlet fitting at wall surface.

Shower Column Installation Instructions

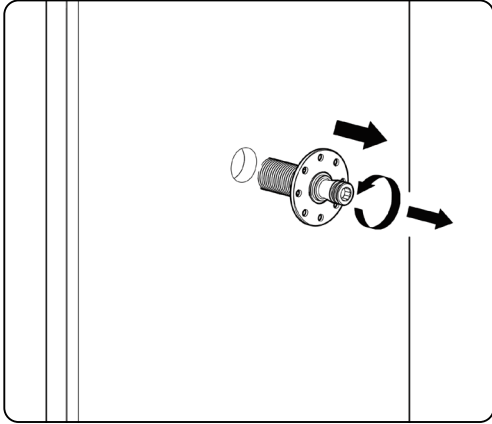

Unscrew inlet fitting from elbow in wall.

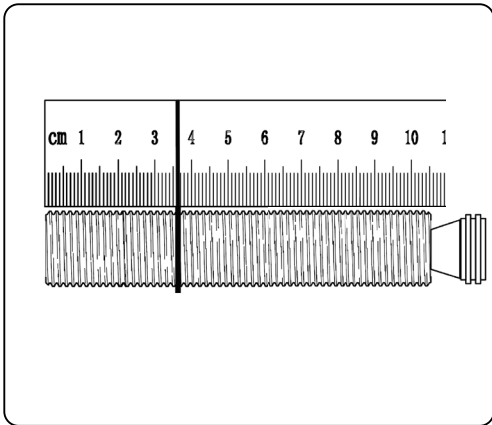

Measure distance from mark on inlet fitting to end of the inlet fitting threads.

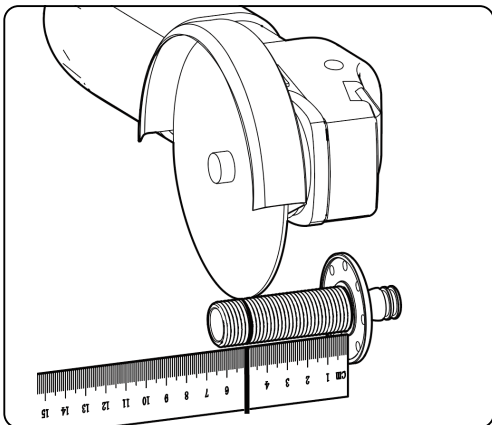

Cut off the excess.

Note: If measurement is between 2-5/16" - 2-5/8" (58-66mm), it does not need to be cut off.

Shower Column Installation Instructions

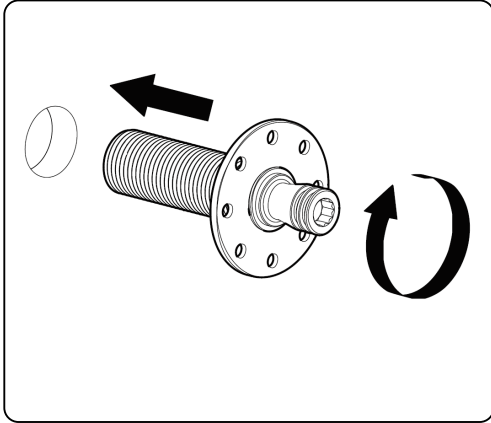

Thread the inlet fitting into the built-in pipe outlet and hand tighten.

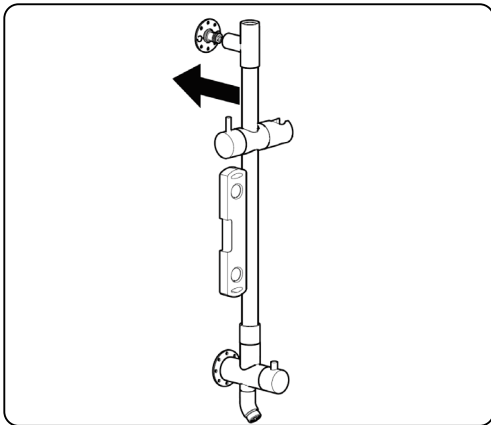

Install the shower column onto the inlet fitting, ensure there is no gap between the shower column and the inlet adapter. Lever the shower column.

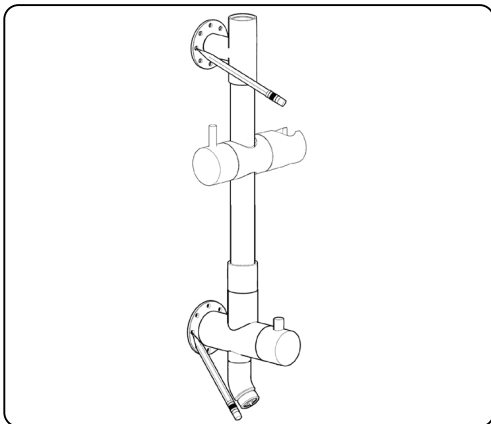

Mark the center slots of the upper mounting flange. Mark the center slots of the lower post and around the lower mounting post.

Note: These are the points where you will drill holes for installing the toggle bolts. Ensure that there are not plumbing, electrical or other obstructions are contained behind the wall in these locations.

Shower Column Installation Instructions

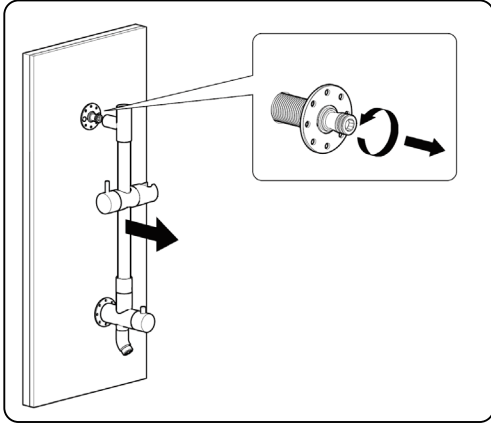

Remove the shower column and inlet fitting.

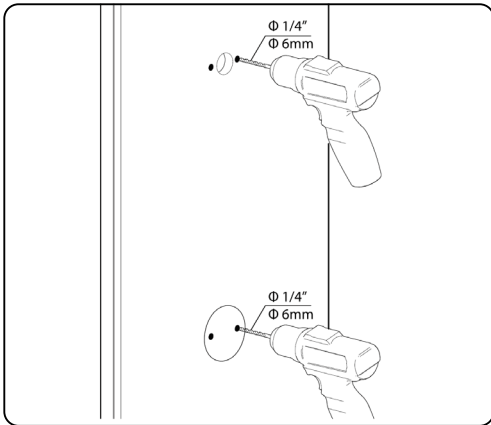

Drill 1/4"(6mm) holes at the mark positions.

Note: Kibi suggested to drill holes for lower mounting post installation, But if drilling holes may broken the pipes inside, the 3M sticker in the package are suggested to use,

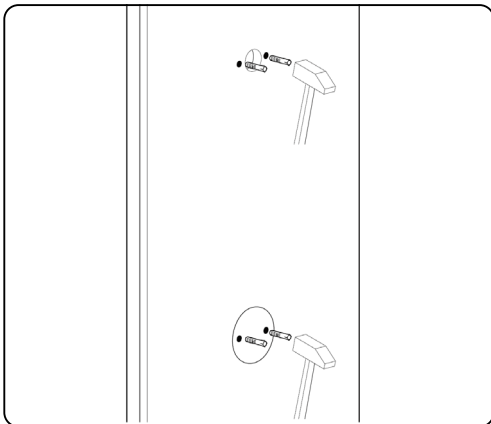

Insert anchors.

Note: Kibi suggested to drill holes for lower mounting post installation, But if drilling holes may broken the pipes inside, the 3M sticker in the package are suggested to use.

Shower Column Installation Instructions

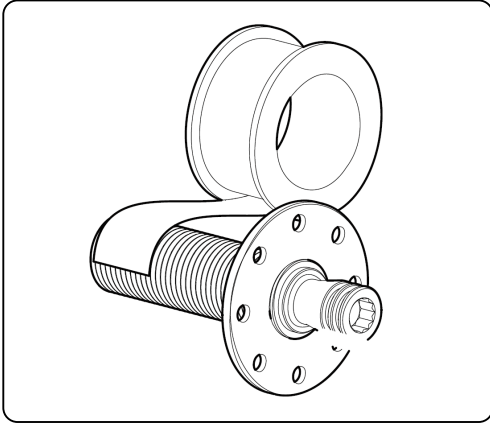

Apply plumbers tape to threaded end on the inlet fitting.

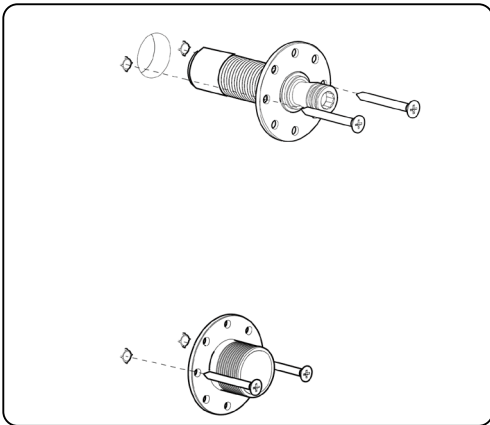

Thread the inlet fitting into the built-in pipe outlet and tighten using a smooth jawed wrench. Assemble set screws into the mounting flange and tighten.

Note: Kibi suggested to drill holes for lower mounting post installation, But if drilling holes may broken the pipes inside, the 3M sticker in the package are suggested to use.

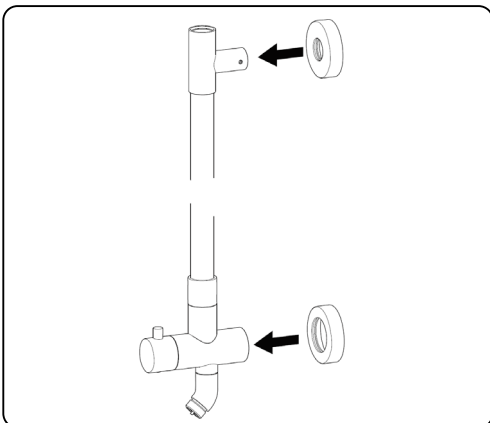

Assemble the upper escutcheon and lower escutcheon onto the upper and lower post of the shower column, respectively.

Shower Column Installation Instructions

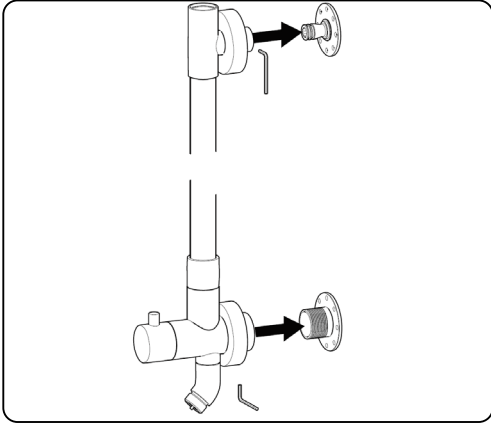

Install the shower column onto the inlet fitting and lower mounting post. Then use the hexagonal wrench to tighten the hexagon socket screw set.

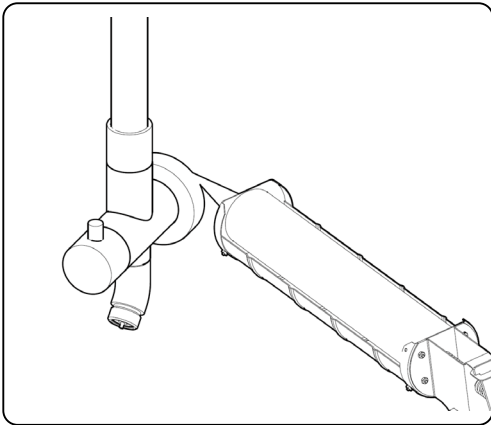

Slide the upper and lower escutcheons back against the finished wall. Apply silicone sealant to the rear lip of the upper and lower escutcheons.

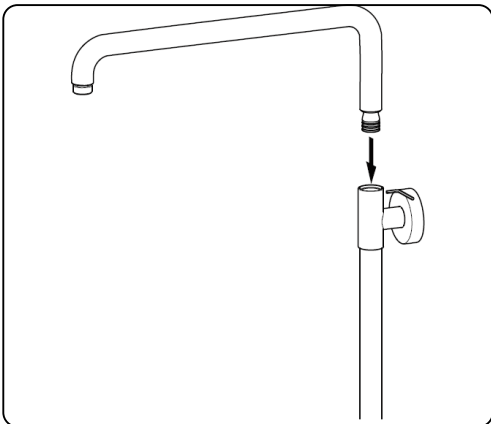

Assemble the overhead shower arm into the shower column. Ensure it is fully seated. Install 1 of the set screws into the shower column and tighten.

Shower Column Installation Instructions

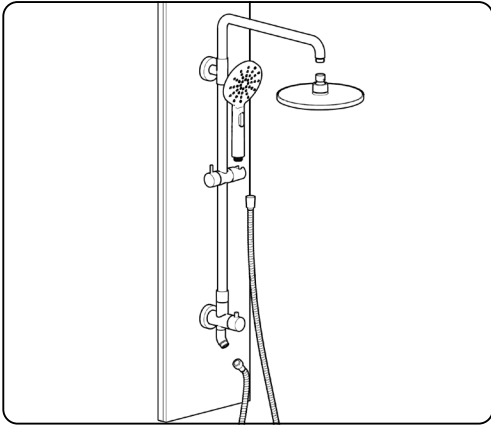

Install shower head, hand shower and hose. Turn on the main water valve.

Note: Check for leak.

Dimensions

KSC401

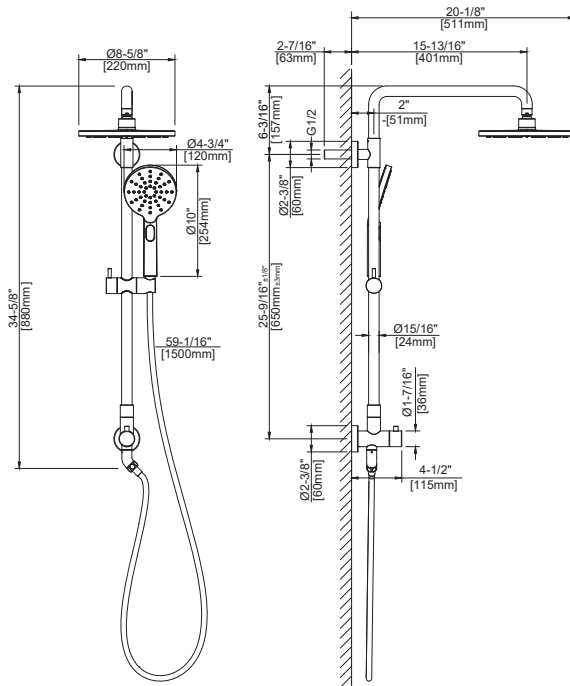

Dimensions

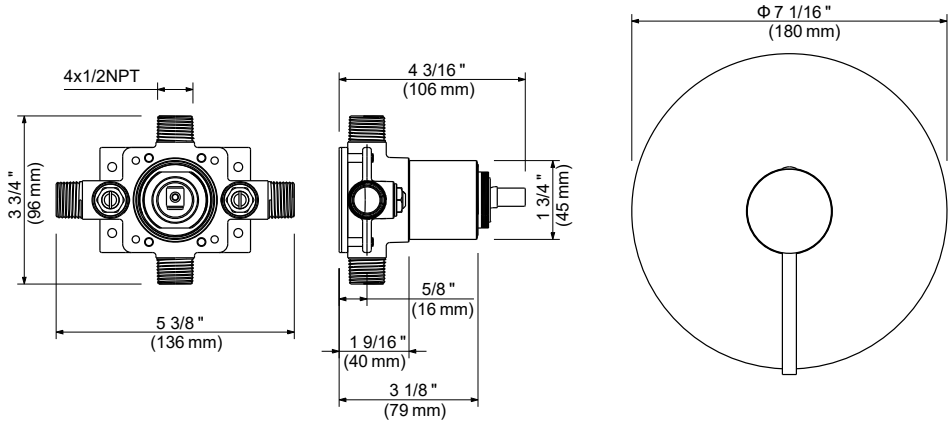

Cleaning and care

Clean the faucet often with a soft cloth to keep it looking like new. For heavy cleaning you can use mild liquid detergents or non-abrasive liquid polisher. Rinse with water and dry with a soft cloth. Avoid abrasive cleaners, steel wool and harsh chemicals as these will dull the finish and void your warranty.

LIMITED LIFETIME WARRANTY

KIBI provides its customers with an extensive warranty as a result of our excellent workmanship and high quality components used in our products.

Mechanical warranty: A limited lifetime warranty is provided on all mechanical parts to be free from manufacturing defects in materials and workmanship under normal use for as long as the original purchaser owns their home.

Finish warranty: A 5-year warranty is provided on all KIBI faucet finishes to the original purchaser against manufacturing defects in materials and workmanship.

At its sole discretion, KIBI will repair or replace any part or finish that proves to be defective in material and/or workmanship under normal installation, use and service.

This warranty is extended to the original consumer owner, but does not cover installation or any other labor charges. In no event shall KIBI be liable for any incidental, consequential or special damages, installation cost, labor, travel time, freight costs incurred, lost profits, or contingent liabilities. KIBI makes no representation that its products comply with any or all local building or plumbing codes. It is the consumer's responsibility to determine local code compliance.