

NOTE(S):
 1. PART NUMBER, "/00" DENOTES PART SHALL HAVE FINISH.

2. APPLY NSF COMPLIANT GREASE TO ANY O-RING, SEALING JOINTS, AND/OR PIVOTAL POINTS.

3. APPLY NSF COMPLIANT LOCTITE TO THREADED AREA.

4. APPLY NSF COMPLIANT REMOVABLE (BLUE) LOCTITE TO THREADED AREA.

5. SILVER SOLDER JOINTS SHALL BE FULLY WETTED VIA CAPILLARY ACTION AND COMPLETELY NON-POROUS.

G
L
B
S

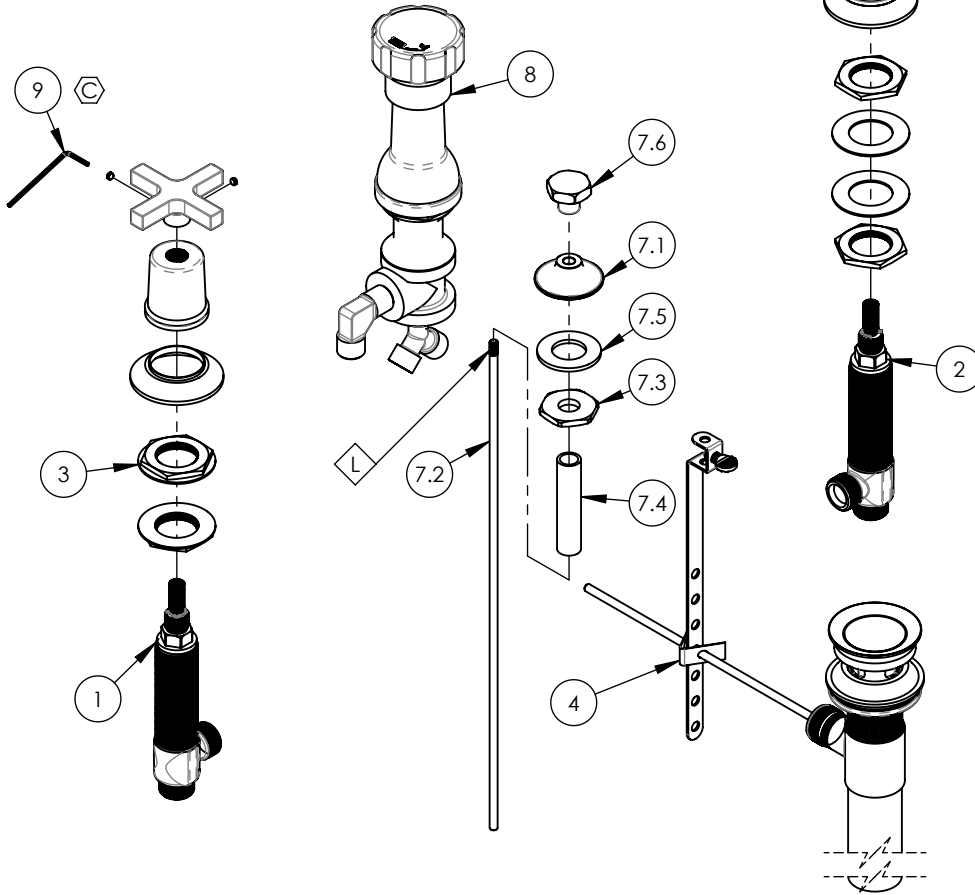

ITEM NO.	PART NUMBER	DESCRIPTION	QTY.
1	1-149	WIDESPREAD VALVE LAV 16PT, HOT, ONLY	1
2	1-150	WIDESPREAD VALVE LAV 16PT, COLD, ONLY	1
3	2-203	MOUNTING NUT KIT, WIDESPREAD LAV	4
4	3-046/00	POP-UP DRAIN ASSEMBLY (2-101, 2-102, & 2-246)	1
5	3-085/00	ASSY, BIDET SPRAYER	1
6	3-132/00	CROSS HANDLE, HEX MODERN, 501 SERIES	2
7	3-145/00	ASSY. BIDET POP-UP ROD, 500/501 SERIES	1
7.1	P09007/00	K4160 POP UP GUIDE	1
7.2	10719/00	POP-UP ROD, 10-24, 14" LONG	1
7.3	P09006	SPECIAL HEX F/BIDET SPRAYER	1
7.4	P32010	9/16-20 x 56 NIPPLE FOR COMPRESSION STEM	1
7.5	P35026	3/4" SAE FLAT WASHER	1
7.6	10920/00	POP-UP KNOB, HEX TRADITIONAL	1
8	3-160/00	BIDET DIVERTER, COMPLETE	1
9	92021	HEX KEY 5/64, FOR 8-32 SET SCREW	1

D5	C	UPDATE HEX KEY	11/18/2021	AMM
ZONE	REV.	DESCRIPTION	DATE	APPROVED
REVISIONS				

1261 LOGAN AVENUE
 COSTA MESA, CALIFORNIA 92626
 PHONE: 714.361.4800
 FAX: 714.617.3120

PHYLIRICH[®]
 Defining Luxury Since 1959

PROPRIETARY AND CONFIDENTIAL
 THE INFORMATION CONTAINED IN THIS DRAWING IS THE SOLE PROPERTY OF PHYLIRICH. ANY REPRODUCTION IN PART OR AS A WHOLE WITHOUT THE WRITTEN PERMISSION OF PHYLIRICH IS PROHIBITED.
DO NOT SCALE DRAWING

BIDET SET, FOUR HOLE, CROSS, HEX MODERN

SIZE A	ASM/PRT NO. 501-60/00	REV C
SCALE: 1:4.5	WEIGHT: lbs.	SHEET 1 OF 2

5

4

3

2

1

E

E

D

D

C

C

B

B

A

A

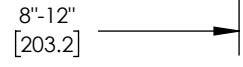
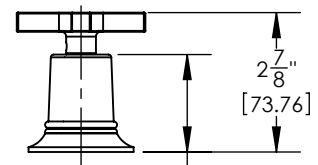
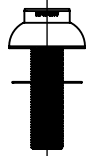
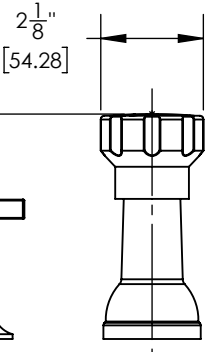
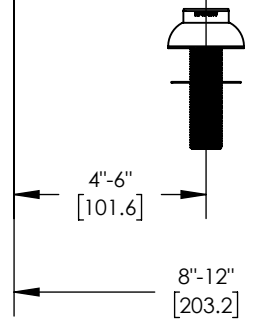
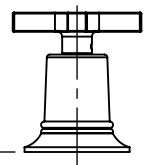
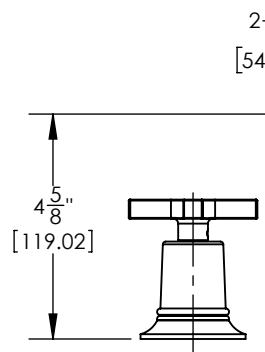
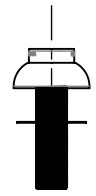
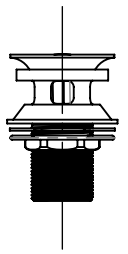
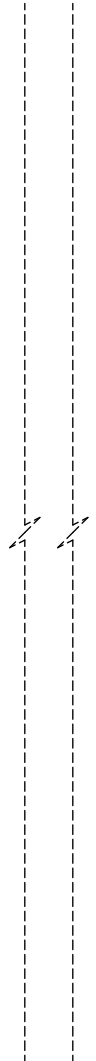
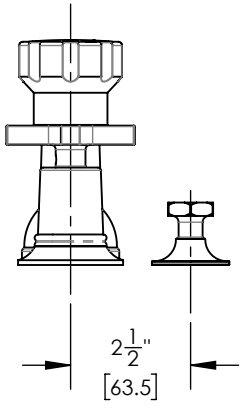
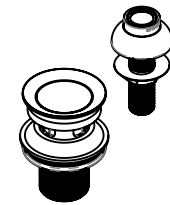
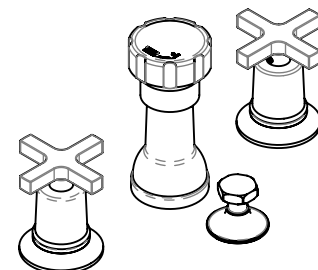

1261 LOGAN AVENUE
COSTA MESA, CALIFORNIA 92626
PHONE: 714.361.4800
FAX: 714.617.3120

PHYLIRICH[®]
Defining Luxury Since 1959

PROPRIETARY AND CONFIDENTIAL
THE INFORMATION CONTAINED IN THIS DRAWING IS THE SOLE PROPERTY OF PHYLIRICH. ANY REPRODUCTION IN PART OR AS A WHOLE WITHOUT THE WRITTEN PERMISSION OF PHYLIRICH IS PROHIBITED.
DO NOT SCALE DRAWING

BIDET SET, FOUR HOLE, CROSS, HEX MODERN

SIZE A	ASM/PRT NO. 501-60/00	REV C
------------------	--------------------------	----------

SCALE: 1:5	WEIGHT: lbs.	SHEET 2 OF 2
------------	--------------	--------------

5

4

3

2

1