

Guide d'installation et d'utilisation • Installation and User's Guide

Tablette • Shelf

Lire toutes les instructions attentivement avant de commencer l'installation. Le bon respect des instructions garantie une installation sûre. Nettoyer régulièrement la surface pour qu'elle reste brillante. Utiliser seulement un nettoyant neutre et un tissu doux. Ne pas utiliser de nettoyant chimique ou d'éponge abrasive.

Read all instructions carefully before proceeding. Following the instructions closely will ensure a safe and secure installation. Clean the surface periodically to maintain a bright surface. Use only a mild-cleaner and soft cloth. Do not use chemicals or scouring pads.

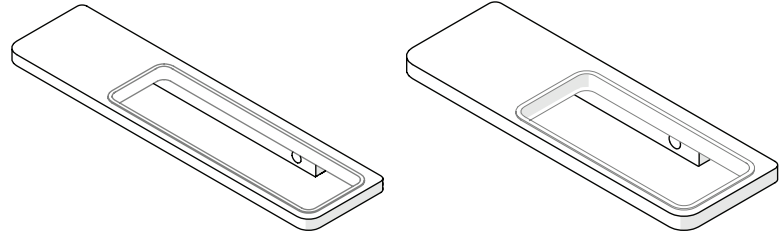

LISTE DES PIÈCES / PARTS LISTING

OUTILS REQUIS / REQUIRED TOOLS

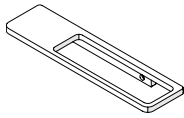

Joint Amovible
Removable Gasket
(1)



Capuchon
Cap
(2)



Vis ST4.5*40mm
Screw ST4.5*40mm
(2)

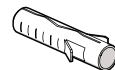

Chevilles
Wall Plugs
(2)



Lunettes de sécurité
Safety Glasses



Perceuse
Drill



Mèche 5/16"
5/16" Drill Bits

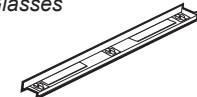

Niveau
Level



Tournevis
Screwdriver

* Utiliser une mèche de 5/16" pour percer des tuiles en céramique.*
Use a 5/16" drill bit when drilling into ceramic tiles.

CARACTÉRISTIQUES / SPECIFICATIONS

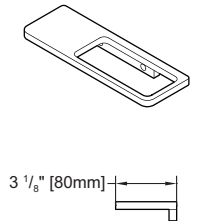
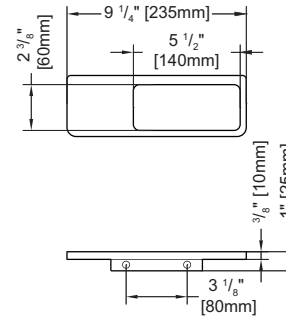
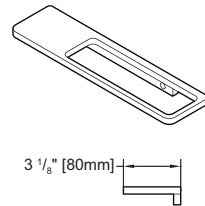
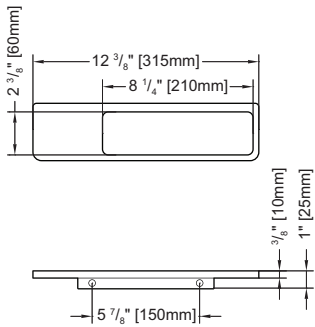

INSTALLATION / INSTALLATION

INSTALLATION / INSTALLATION

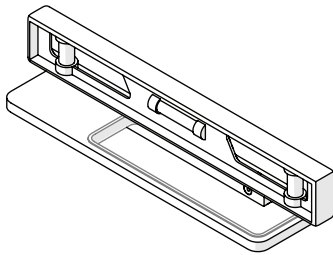

Placer la barre sur le mur avec un niveau /
Place the bar on the wall with a level

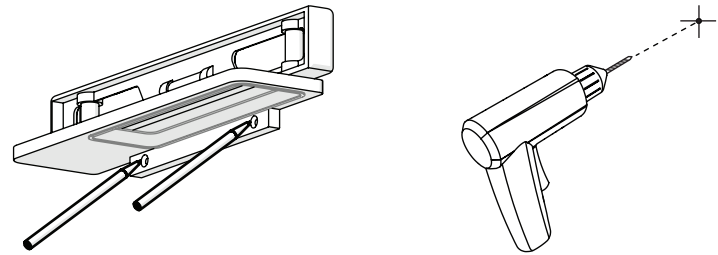

Marquer les points de perçage et percer /
Mark the drilling locations and drill

INSTALLATION / INSTALLATION

INSTALLATION / INSTALLATION

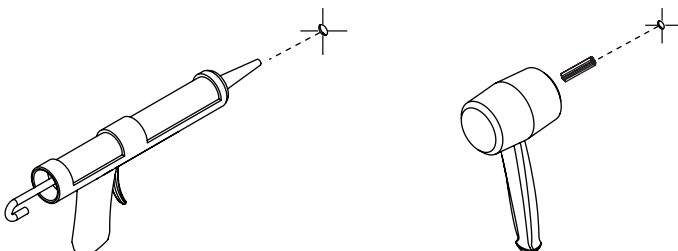

Siliconer et insérer les chevilles /
Silicone and insert the wall plugs

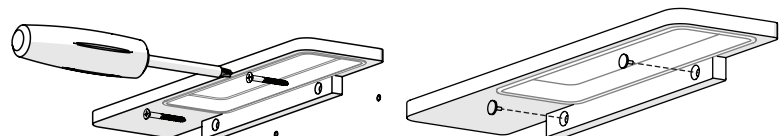

Installer la barre et les capuchons /
Install the bar and the caps